

INSTRUCTION MANUAL (M_Ver. 1.2_HD(20101007))

H.264 Video Compression

Digital Video Recorder

About this user guide

Before installing and using this unit, please read this user guide carefully.

Be sure to keep it handy for later reference.

Safety Precautions

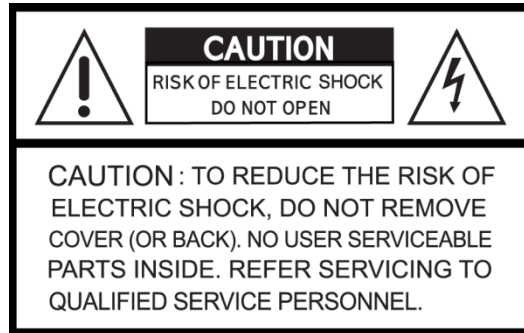

Explanation of Graphical Symbols



This symbol indicates the presence of important operating and maintenance (servicing) instructions in the literature accompanying the product.

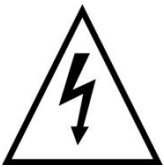

This symbol indicates the presence of uninsulated "dangerous voltage" within the product's enclosure that may be of sufficient magnitude to constitute a risk of electric shock to persons.

WARNING

To reduce a risk of fire or electric shock, do not expose this product to rain or moisture.

CAUTION

Changes or modifications not expressly approved by the manufacturer may void the user's authority to operate this equipment.

CAUTION

Danger of explosion if battery is incorrectly replaced.

Replace only with the same or equivalent type recommended by the manufacturer.

Discard used batteries according to the manufacturer's instructions.

These precautions must be followed for safety reasons.



Warning

- Do not use if the unit emits smoke, strange sounds are heard, or odor is emitted.
- Make sure the power cable is not damaged.
- Make sure there is no dust accumulation on the power plug or the outlet.
- Disassembly prohibited
- Do not place any foreign objects inside the unit.
- Do not place a container holding water or other liquids above the unit when it is connected to power.
- Do not allow the unit to get wet.
- Do not use during thunder/thunder storms.
- Do not place in an unstable position.
- Do not expose to shock or vibration.
- Do not use this unit in areas where it is exposed to the possibility of explosion.



Caution

- Do not pull on the power cable when removing the power plug from the outlet.
- Do not touch the power plug with wet hands.
- Do not sit on.
- Make sure the cables are connected properly.
- Do not place heavy objects on connected units.
- Never move this unit while the power is turned on.
- Remove the power plug from the outlet when the unit is going to remain unused for long periods of time.
- Do not block the cooling fans or air ducts.
- Do not expose to extreme temperatures or humidity changes.
- The Socket Outlet shall be installed near the equipment and shall be easily accessible

Warning

Installation and servicing should be performed only by qualified and experienced personnel.







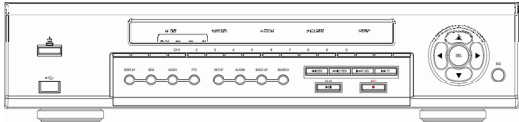

Turn off the power of the DVR when connecting cameras, audio or sensor cables.

The manufacturer is not responsible for any damage caused by improper use of the product or failure to follow instructions for the product.

The manufacturer is not responsible for any problems caused by or resulting from the user physically opening the DVR for examination or attempting to fix the unit. The manufacturer may not be held liable for any issues with the unit if the warranty seal is removed.

Product Components

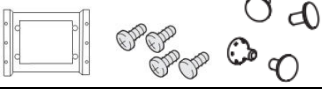
The package contains the main unit and its components as specified below. When you purchase the unit, Please check to ensure the components specified below are included.

DVR Set	
Client Software CD	
Remote Control	
Battery 1.5V (AAA x 2EA)	
User Guide	
HDD data cable	
HDD mounting bracket & Screw	
HDD fixing screw	

Items	4CH HD DVR	
		Basic version
HDD data cable		4EA
HDD mounting bracket		4EA
HDD Mounting bracket screw		4EA
HDD/DVD-RW fixing screw		16 EA

Basic function of the MOUSE

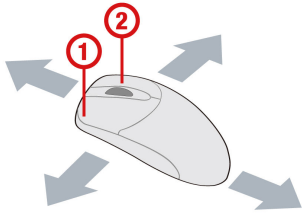

① : Left button: SELECT function

② : Right button: Go to Sub Menu

① : Double click: Change Full Screen or Split Screen

Mounting the HARD DISK

1. Unfasten the cover of the unit.

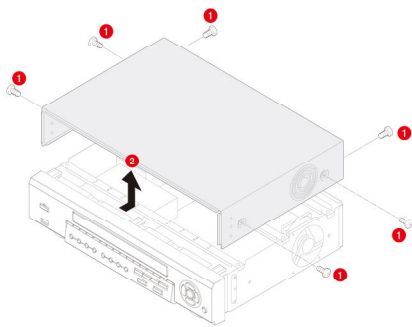

2. Fix the supplied HDD mounting bracket to the hard disk using the supplied mounting bracket screws.

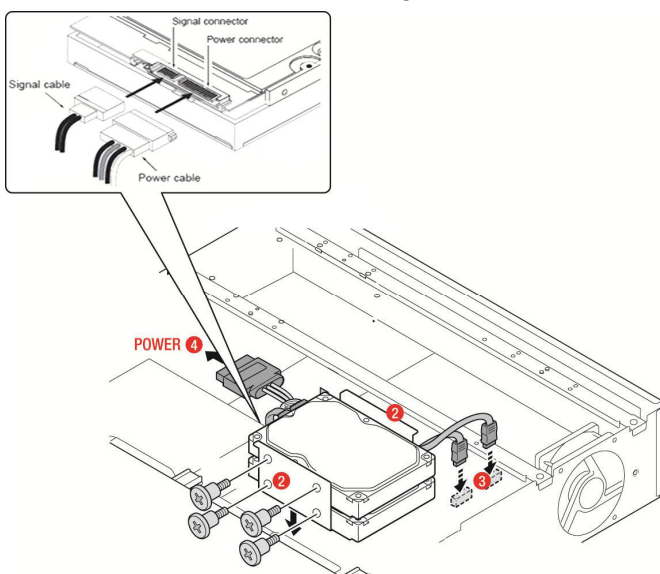

3. Insert the HDD bracket to the hole and fix the screw.

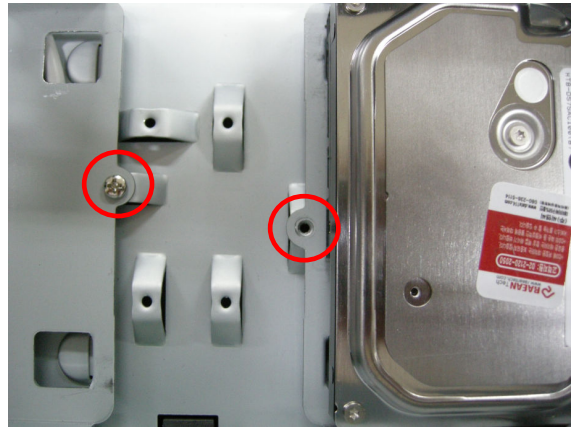

4. Connect the supplied SATA cable and power cable to the hard disk.

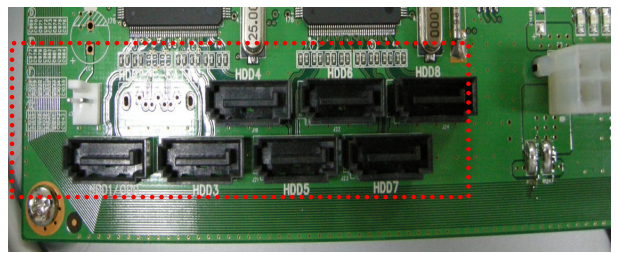
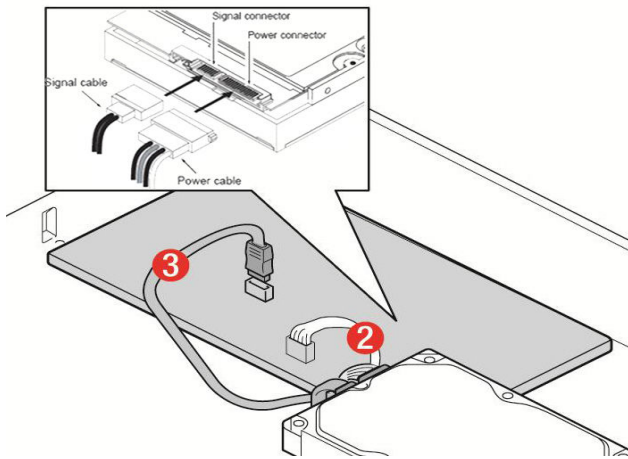

NOTE) HDD should be connected in order from HDD1/ODD, HDD3, HDD4, HDD5, HDD6, HDD7, HDD8. If HDD is connected like HDD1/ODD, HDD4 as skipping HDD3 connector if not DVR may malfunction.

Available Model and Max. Recording Speed

Model	Recording Speed (Maximum)
	HD 720p(1280x720)
HD-0410S(4CH)	120fps

Specification

ITEM		Specification	
Video	Input	Channel Input Level	4CH HD-SDI (720p25/30/50/60)
		Video Loss Check	YES
	Output	Main Monitor Output	HDMI (1280x720)
		Sub Monitor Output	VGA (1280x1024)
Spot		CVBS	
Audio	Input	4 RCA	
	Output	1 RCA	
	Audio Codec	G.711	
Alarm	Sensor Input	4CH, NC/NO Selectable	
	Alarm Out	1CH out by Sensor, Motion and Video Loss	
Serial	POS	RS-232C	
	PTZ	RS-485	
	Controller	RS-485	
Network	Ethernet	RJ-45, 10/100/1000Base-T, Auto MDI/MDIX	
Operation	PentaPlex	Live/Record/Playback/Backup/Network	
Live	Digital Zoom	Selected Area Maximize	
	Channel Sequence	3 ~ 60 seconds Auto	
Recording	Compression	H.264	
	Resolution	1280x720 / 640x360 selectable per channel	
	Recording Quality Grade	4 Levels	
	Recording Mode	Continuous, Schedule, Motion, Sensor, Manual	
	Motion Detection	Setup by Grid	
	Pre Recording	Min. 15 seconds and Max. 20 minutes	
	Post Recording	10 ~ 30 seconds	
Playback	Digital Zoom	Zoom-in of specific area	
	Speed	FF	x1/4, x1/2, x2, x4, x16 and x32
		FR	x2, x4, x16 and x32
	Search Mode	Timeline, Event, Archive, Log, Specific Time	

Backup	File Format		JPEG/Proprietary Format
	Media		USB/External HDD/Network
	Built-in Viewer		Yes
Network	Dual Streaming for Live		H.264 CIF 120fps
	Playback		H.264 HD 30fps
	Streaming		RTP/RTSP/RTCP
	Protocols		HTTP, DDNS, NTP, SMTP
Storage	HDD	Interface	SATA, e-SATA
		Max. Capacity of HDD	2TB
		Max. Internal HDDs	4EA
	External Storage		1 e-SATA
	Filesystem		Self-developed, Reliable and Stable Filesystem
	Raid		Yes (TBD)
	SMART		HDD Error Check and Reporting
User Interface	Menu Display		Graphic User Interface
	Input Method		Mouse, Remote Controller and Keypad
Network Access	PC Client		Live, Search/Playback, Backup, PTZF Camera Control
	Web Viewer		Live, Search/Playback, Backup, PTZF Camera Control
Features	DST (Daylight Saving Time)		Yes
	Internal Beep		By Alarm, Motion, Video Loss, HDD Error
	Multi Language		Yes
	Software Upgrade		By USB, Network Remote Upgrade (TBD)
	NTP (Network Time Protocol)		Yes
	Watermarking		Yes (TBD)
	3G Mobile		iPhone, Blackberry
	Remote Setup		Yes
General	Operation Condition		0~40C, Humidity 20~80%
	Power		AC 100~127V/200~240V, 5~60Hz, 280W
	Net Weight (Gross Weight)		6KGS (9.5KGS) / 13.2LBS (20.9LBS)
	Unit Dimension (W x D x H)		417mm x 432mm x 99mm / 16.4" x 17" x 3.9"

Specifications are subject to change without notice

Table of Contents

1. Name, Function and Connection.....	11
1-1. Front Panel.....	11
1-2. Rear Panel	13
1-3. Remote control.....	14
2. Setting up the DVR.....	15
2-1. Setup – Main Screen.....	15
2-2. Setup – Display Mode	18
2-3. Setup – Recording Mode.....	19
2-3-1. Recording Schedules	20
2-4. Setup – Device Mode	21
2-4-1. ALARM-OUT	23
2-4-2 PTZ Setup.....	23
2-4-3. Motion Zone Setup.....	24
2-5. Setup – Storage Mode.....	25
2-6. Setup – System Mode	26
2-7. Setup – SECURITY Mode	28
2-8. Setup – Network Mode	29
2-8-1. Ports.....	30
2-8-2. Network Types	31
2-8-2-1.STATIC.....	31
2-8-2-2. DHCP.....	32
2-9. Setup - CONFIG Mode	33
3. Saving Setup	34
4. Live, Search, and Playback	34
4-1. Live Viewing Screen	34
4-2. SEARCH Screen	36
4-2-1. TIME-LINE Search	37
4-2-2. Event Search.....	38
4-2-3. Go To First Time	38
4-2-4. Go To Last Time	38
4-2-5. Go To Specific Time.....	39
4-2-6. Log Search.....	39
4-2-7. Archive Search	39
4-3. Play mode	39
5. PTZ Control	40
6. Back up	42

6-1. Still Image backup onto USB flash memory	42
6-2. Video backup onto USB flash memory	43
6-3. Transferring still images or video from the ARCHIVE list	43
6-4. Playback of Backup Video	43
7. Upgrading Firmware	44
8. Network access using the UMS Single viewer	45
8-1. PC requirements	45
8-2. Installing the network viewer.....	45
8-3. Live monitoring mode and functions.	46
8-4. Bi directional audio	48
8-5. Remote search mode and functions	49
8-6. PC System configuration	52
9. Network access using the UMS Multi Software.....	54
9-1. Installing the program	54
9-2. Live Window.....	55
9-3. Search and Playback Window.	58
9-4. Setup of UMS Multi Client.....	61
9-5. Remote Setup	65
9-6. Operation	75
10. Network – By an web-browser viewer	86
APPENDIX: How to connect network.....	87
A. How to set IP address of the DVR and open TCP port of the router?.....	87
B. How to access DVR from Remote PC?	90

1. Name, Function and Connection

1-1. Front Panel

The following information will help you to operate the front panel controls.

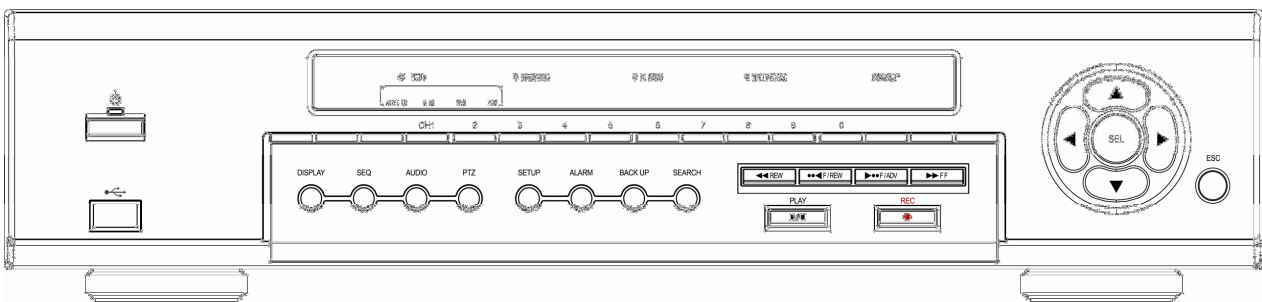



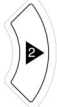







Figure 2.1.1. Front panel

Table 2.1.1. Indication lamps

Name	Description
POWER	LED light is on when power is applied to the system. Green – Power On, Orange – Power Off
HDD	LED light is on when the system is recording video data.
ALARM	LED light is on when alarm sensor(s) is/are triggered or motion is detected.
NETWORK	LED light is on when client is connected to the system through the network.
CH1, 2, 3, 4	LED light is on when the channel is recorded.

Table 2.1.2. Front panel buttons

Name	Description
DISPLAY	Press to toggle the screen mode. (Full or Quad)
SEQ	Press to start auto sequencing of the screen in full screen mode. (Toggle)
AUDIO	Press to set the audio output mode. (Mute, 1CH to 4CH)
PTZ	Press to control PTZ operation
SETUP	Press to launch SETUP menu.
ALARM	Press to set the alarm output mode. (On or Off)
BACKUP	Press to start operations involving archiving in live or playback mode.
SEARCH	Press to go to the search menu. Event search /Time line search /Log /Archive search

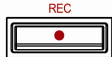
ESC	Press for temporal storage of the changed value or to return to previous menu screen.
	Press to move up the menu items in setup mode and to select camera 1 in live mode. It is also used as the number 1 when entering password.
	Press to move right in the menu or to change the values in setup mode and to select camera 2 in live mode. It is also used as the number 2 when entering password.
	Press to move down the menu items in setup mode and to select camera 3 in live mode. It is also used as the number 3 when entering password.
	Press to move left in the menu or to change the values in setup mode and to select camera 4 in live mode. It is also used as the number 4 when entering password.
	Press to select full screen or quad view in live display mode. It is also used to select desired menu item or to store the setup value in the menu.
PLAY/PAUSE	Press to play or to pause the footage in playback mode
	Press to rewind the footage at 1x, 2x, 4x, 8x, 16x and 32x speed in playback mode.
	Jump/Step backward. – In playback mode, the playback position moves 60 seconds backward.
	Jump/Step forward – In playback mode, the playback position moves 60 seconds forward.
	Press to fast forward the footage at 1x, 2x, 4x, 8x, 16x and 32x speeds in playback mode.
	Press to start MANUAL RECORDING
USB port	There is a USB port located on the left side of the front panel. This USB port is used to archive footage into a USB storage device or mouse control. (USB 2.0 connector)
NUM KEY	CH1, 2, 3, 4 Channel selection button.

1-2. Rear Panel

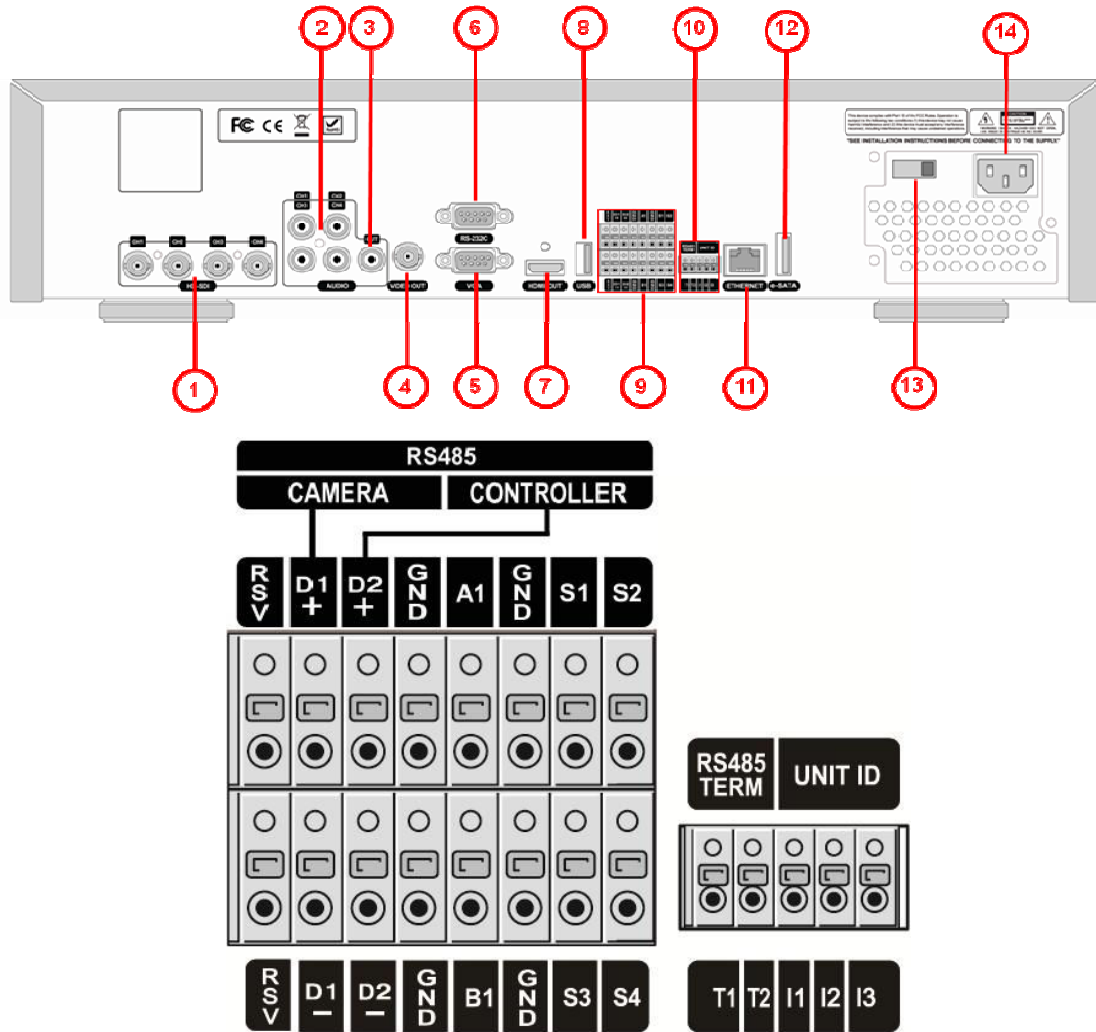

Figure 2.2.1. Rear Panel

Table 2.2.1. Rear panel connections

NO	Connection	Purpose
1	VIDEO IN	4 BNC connectors for video input. (HD-SDI)
2	AUDIO IN	4 connectors for audio input.
3	AUDIO OUT	1 connector for audio output.
4	VIDEO OUT	Spot output (To be supported)
5	VGA	Connector for VGA monitor.
6	RS-232	POS Interface (TBD).

7	HDMI OUT	Main Video Output (1280x720P)
8	USB Port	Connector for Mouse or Backup
9	RSV	Reserved PIN for additional feature
	D1+	1 st RS-485 port
	D2+	2nd RS-485 port
	A1, B1	Alarm Output Connector for Alarm Device
	SENSOR IN	4 connectors for sensor device connection. (S1 ~ S4)
10	TERMINATE	RS-485 termination switch for 1 st and 2 nd .
	UNIT ID	Reserve PIN for additional feature
11	ETHERNET	RJ-45 connector for network function
12	E-SATA	To archive still-image or video into a External Storage HDD . RAID Units to be available in the future
13	Input Voltage	Select input voltage according to local electricity standard
14	POWER SOCKET	Connect for AC110V~250V

1-3. Remote control

RECORD	Manual recording
DISPLAY	Display of Full, Quad,9 or 16 split screen
F/REW	Jump 60 seconds backward
PLAY/PAUSE	Play/Pause
F/ADV	Jump 60 seconds forward
REW	Rewind
BACKUP	Backup still or video data
FF	Fast Forward
ALARM	Disable alarm operation
SETUP	Setup menu screen
ID	DVR ID (ID Button + DVR ID number)
AUDIO	Mute, Single(1CH), MIX(4CH)
LOCK	Lock all of key functions
SEQ	Sequence of Full or Quad view
PTZ	PTZ menu screen
SEARCH	Search menu screen
DIRECTION KEY	Direction key
SELECT	Select or display of split screen
ESC	Esc



NUMBER 1~9,0	Channel 1 to 9 / 10CH->press 0
+10	Channel 11 to16 11CH->press +10 and number 1 16CH->press +10 and number 6

2. Setting up the DVR

The following sections detail the initial setup of a DVR.

2-1. Setup – Main Screen

To enter the setup menu, select MENU and SETUP on the screen using the mouse or press the SETUP

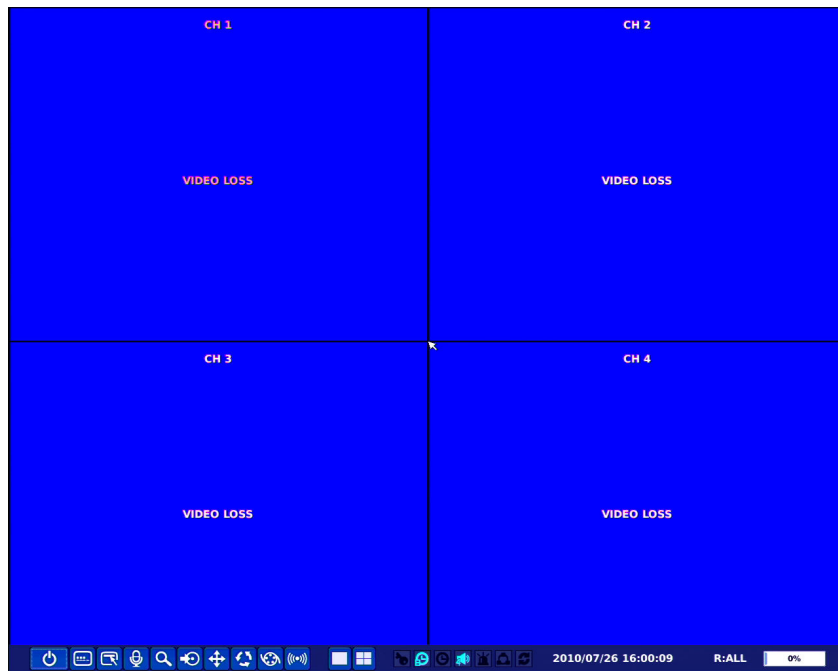

button on the front panel. Then select a user type. User can select one of user types (ADMIN, USER1, USER2, USER3) using the control button (◀ ▲ ▶ ▼) on the front panel and press SEL button. Input the password by front key panel, mouse or remote controller.

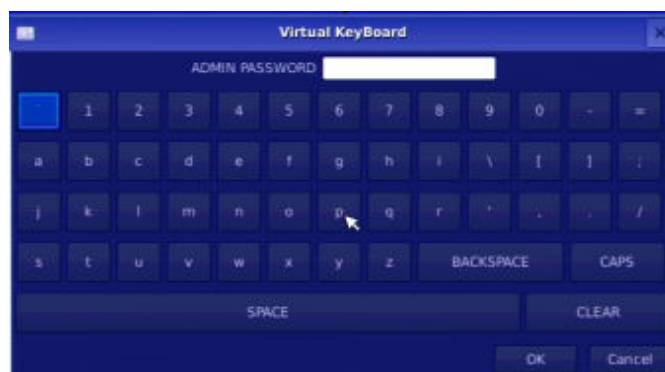
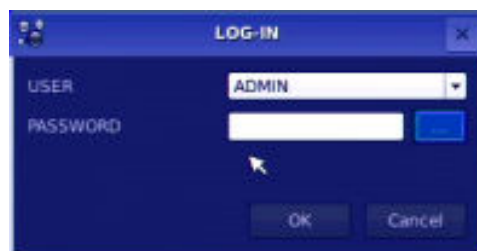

Use the Virtual Keyboard when you use front key and mouse. The factory default password is 1111. It is highly recommended to assign a new password to protect the system. User can assign a new password in SECURITY setup menu.

Table 2.1.1. Setup menu tree

- DISPLAY
 - OSD
 - OSD CONTRAST

- SEQUENCE
- SEQ-DWELL TIME
- CHANNEL
 - NAME

■ RECORD

- CHANNEL
 - FRAME RATE
 - QUALITY
 - RECORDING
 - SENSOR RECORDING
 - PRE RECORD
 - POST EVENT RECORD
 - AUDIO
 - SCHEDULE
 - RESOLUTION

■ DEVICE

- ALARM OUT
- PTZ
- CHANNEL
 - MOTION ZONE
 - MOTION SENSITIVITY
- KEY TONE
- REMOTE CONTROL ID
- SENSOR
 - TYPE

■ STORAGE

- OVERWRITE
- DISK FORMAT
- DISK INFO
- RECORDING LIMIT
 - RECORDING LIMIT DAYS

■ SYSTEM

- DVR-ID
- DESCRIPTION
- LANGUAGE
- DATE FORMAT
- SET DATE & TIME
- CLIENT ACCESS
- BANDWIDTH SAVING

- NTP
- SEND EMAIL
- SECURITY
 - USER AUTHENTICATION
 - USER PASSOWRD
- NETWORK
 - PORT
 - WEB PORT
 - NETWORK TYPE (DHCP, STATIC)
 - DDNS
- CONFIG
 - SAVE SETUP TO A USB
 - LOAD SETUP FROM A USB
 - LOAD DEFAULT
 - LOAD FACTORY DEFAULT

2-2. Setup – Display Mode

Press the SETUP button and enter the password. The setup menu is displayed as picture below. Select DISPLAY icon and press SEL button to enter the setup menu item. Navigate through the menu items using the control button (◀ ▲ ▶ ▼) and change the value of the menu item using the control button (◀ ▲ ▶ ▼). To return to setup menu screen, press the ESC button.



Figure 2.2.1. Display mode setup screen

Table 2.2.1. Menu items in DISPLAY mode setup

Item	Description
OSD	Enable/disable on-screen-display. Select ON: show it on the screen, Select OFF: Disappear on the screen.
SEQUENCE	Enable/disable sequential display of video in full screen mode.
SEQ-DWELL TIME	Set the dwell time of each, single channel display in sequential display

	mode (HD-0410S) (3~60seconds) Quad or 9 channels display in sequential display mode.(1-60seconds) (HD-0810S, HD-1610S) (1~60seconds)
OSD CONTRAST	Set the visibility level of the On Screen Display (OSD).(0-100)
CHANNEL	Select a channel for applying the following settings using the control button (◀ ▲ ▶ ▼). Press SEL button to change the channel.
NAME	Set the channel name. Press SEL button and set the channel name and select OK using the control button (◀ ▲ ▶ ▼).

2-3. Setup – Recording Mode

Press the SETUP button and enter the password. The setup menu is displayed as picture below. Select RECORD icon and press SEL button to enter the setup menu item. Navigate through the menu items using the control button (◀ ▲ ▶ ▼) and change the value of the menu item using the control button (◀ ▲ ▶ ▼). To return to setup menu screen, press the ESC button.



Figure 2.3.1. Recording mode setup screen

Table 2.3.1. Menu items in Recording mode setup

Menu item	Description
CHANNEL	Select a channel for applying the following settings using the control button (◀ ▲ ▶ ▼). Press SEL button to change the setting value of all channels at once. Once you select an item, then press SEL to set value for all channels. Use virtual keyboard for all setting on one screen as you want as bellow picture.



FRAME RATE	Set the frame rate for the specified channel. The sum of the frame rate values from each channel cannot exceed the maximum frame rates for a specific recording resolution. Typical values of the maximum frame rate for video are 120/100 fps
QUALITY	Select the recording quality for the specified channel. Options are: Economy, Standard, High and Super.
RECORDING	Assign the recording mode for each channel. Options are: Continuous, By Motion, By Sensor, By Schedule or Disable.
SENSOR RECORDING	Enable setting up to 4 sensors for the specified channel using the control button (◀ ▲ ▶ ▼).
PRE RECORD	Enable/disable pre-event recording. Pre-event recording time is 15 seconds to 20 minutes(Selectable)
POST EVENT RECORD	Set the post event recording time duration for the specified channel. (10-30 seconds)
AUDIO	Enable/disable audio recording for the specified channel. <ul style="list-style-type: none"> ● Fixed-available on only from channel 1 to channel 4.
SCHEDULE	Set the recording schedule. Press SEL to go to schedule setup screen.
RESOLUTION	Set the resolution to 1280X720, 640X360

2-3-1. Recording Schedules

To setup a recording schedule, select SCHEDULE in the RECORD menu. Navigate through the items using the control button (◀ ▲ ▶ ▼).

Once the channel 1 is selected, SCHEDULE-CH1 screen is displayed. Select ALL or each day using the control button (◀ ▲ ▶ ▼) and set the recording mode using the SEL button repeatedly

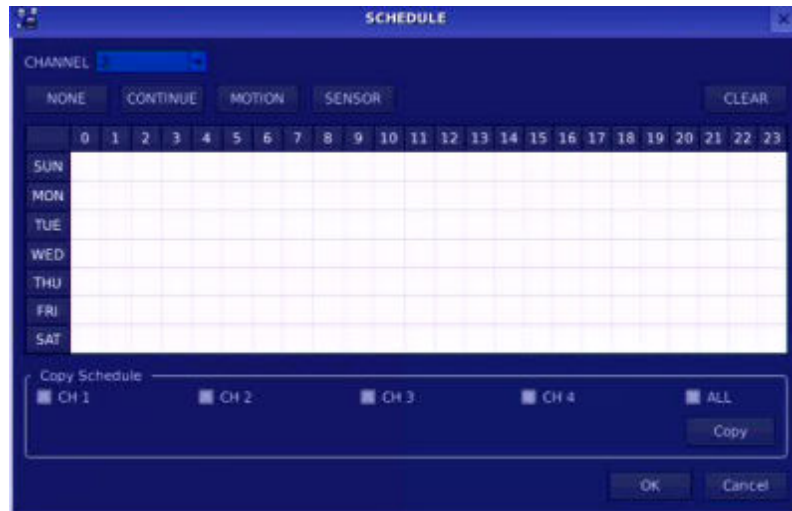

Figure 2.3.2. Schedule recording setup screen

- C: CONTINUOUS recording, When you select the color will change to Blue Color
- M: MOTION recording, When you select the color will change to Yellow Color
- S: SENSOR recording, When you select the color will change to Red Color
- : Does not record

[ALL]: Move the cursor to ALL and select a recording mode C,M or S using the SEL button to set the same setting for every day.

[SUN to SAT]: Move the cursor to SUN to SAT and select a recording mode C,M or S using the SEL button to set the same setting for the whole day.

[Vertical Bar “ | “]: Move the cursor to ALL and move the cursor to the specific time using the control button (◀ ▲ ▶ ▼). And select a recording mode C,M or S using the SEL button to set the same setting.

[SEL]: The recording mode can be selected by pressing repeatedly the SEL button.

[COPY FROM] [COPY TO]: Set the channel 1 schedule and select COPY TO using the control button (◀ ▲ ▶ ▼), select CH2 using the control button (◀ ▲ ▶ ▼) and press the SEL button. Then the CH1 schedule is copied to CH2.

To return to setup menu screen, press the ESC button.

2-4. Setup – Device Mode

Press the SETUP button and enter the password. The setup menu is displayed as picture below. Select DEVICE icon and press SEL button to enter the setup menu item. Navigate through the menu items using the control button (◀ ▲ ▶ ▼) and change the value of the menu item using the control button (◀ ▲ ▶ ▼).To return to setup menu screen, press the ESC button.



Figure 2.4.1. Device mode setup screen

Table 3.4.1. Menu items in Device Setup screen

Item	Description
ALARM OUT	Set the sensor, motion, and video loss for each alarm.
PTZ	Set the PTZ camera speed, number, type and ID.
CHANNEL	Select specified channel for motion zone setup.
MOTION ZONE	Select either Full Zone or Partial Zone for motion sensing.
MOTION SENSITIVITY	Set the motion sensitivity for the specified channel. Control the motion sensitivity from 1 to 9.
KEY TONE	Enable/disable key tone.
REMOTE CONTROL ID	Select an ID of remote control. 1. Select ID. 2. Press the same number as ID set in DVR on a remote control. 3. Then icon will be displayed on Live screen of DVR that respond to the remote control. The options are from 00 to 99
SENSOR	Select sensor NO from 1 to 4,9,16.
TYPE	Set the type of sensor for the specified channel. Options are: OFF, N/O (normal open), and N/C (normal closed).

2-4-1. ALARM-OUT

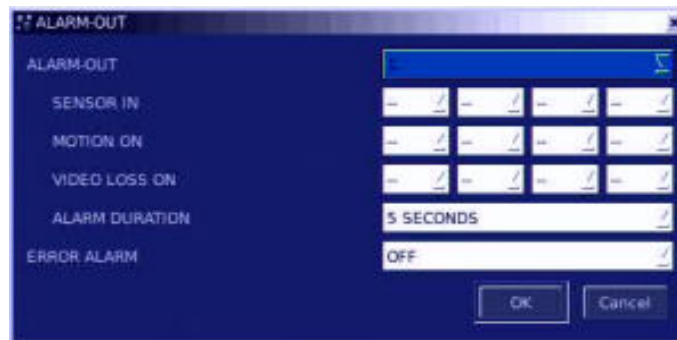

Figure 2.4.2. ALARM-OUT setup screen

Table 3.4.2. Menu item in ALARM-OUT Setup screen

Item	Description
ALARM OUT	Select an alarm out number. Available NO: 4CH(1)
SENSOR IN	Enable setting up to 4 cameras for each alarm.
MOTION ON	Enable setting up to 4 cameras for each alarm.
VIDEO LOSS ON	Enable setting up to 4 cameras for each alarm.
ALARM DURATION	Set the alarm dwell time from 5 to 60 seconds.
ERROR ALARM	Set the error type for the alarm activation. The options are OFF, ALL, HDD ERROR and VIDEO LOSS.

2-4-2 PTZ Setup

To control the PTZ functions of the camera, connect a controller to the RS-485 port.

- ① Connect the RS-485 cables of PTZ camera to the RS-485 port on the rear panel.

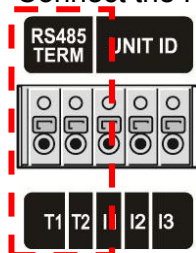

- ② Press SEL button or double click to enter the menu. Then PTZ menu screen is displayed.



Figure 2.4.3. PTZ Control Setup Screen

Note: For speed dome cameras that support RS-485, connect them directly to the RS-485 port. If the camera is controlled with RS-232C, use an RS-485 to RS-232C signal converter.

On the PTZ control setup screen, you can select or set the protocol type of the camera that is the same as the one installed on the site. If the camera has a specific camera ID, select the camera ID using the control button (◀ ▲ ▶ ▼).

The following options are available on the PTZ setup screen.

CHANNEL (channel number that the PTZ is connected to)

NAME (protocol type)

SPEED (19200, 14400, 9600, 4800, 2400)

ID (0-63)

2-4-3. Motion Zone Setup

Select MOTION ZONE using the control button (◀ ▲ ▶ ▼) and select either PARTIAL ZONE or FULL ZONE using the control button (◀ ▲ ▶ ▼). And press the SEL button.

If FULL ZONE is selected, the motion setting screen is not displayed. Only set the level of sensitivity for MOTION SENSITIVITY.

FULL ZONE: The motion sensor is active on the whole screen.

PARTIAL ZONE: The motion sensor is active in the set detection frame.

Select the sensor detection position using the control button (◀ ▲ ▶ ▼) and press the SEL button.

Then the color of the position which is selected will be changed. Press ESC button to return to the DEVICE setup menu.

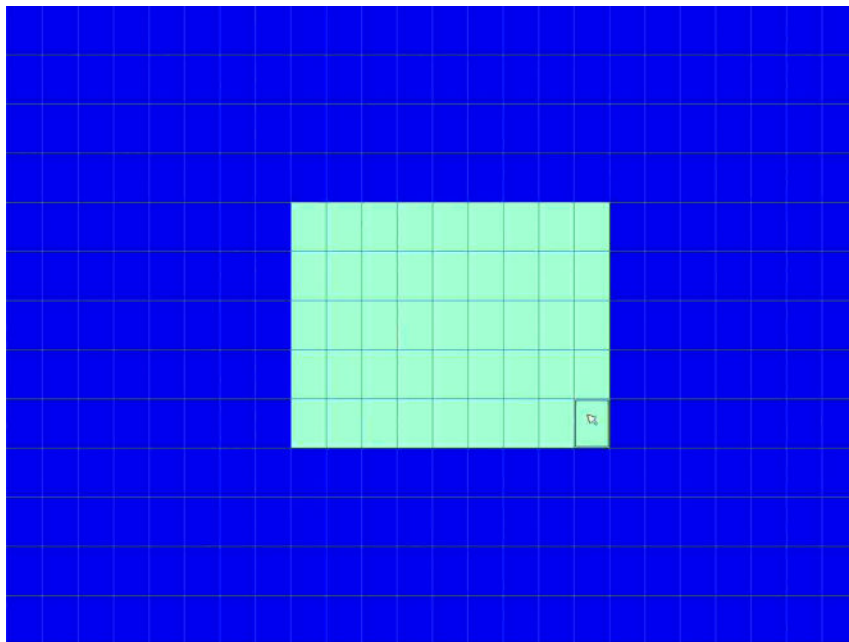

Figure 2.4.4. Motion Zone selection screen

2-5. Setup – Storage Mode

Press the SETUP button and enter the password. The setup menu is displayed as picture below. Select STORAGE icon and press SEL button to enter the setup menu item. Navigate through the menu items using the control button (◀ ▲ ▶ ▼) and change the value of the menu item using the control button (◀ ▲ ▶ ▼). To return to setup menu screen, press the ESC button.

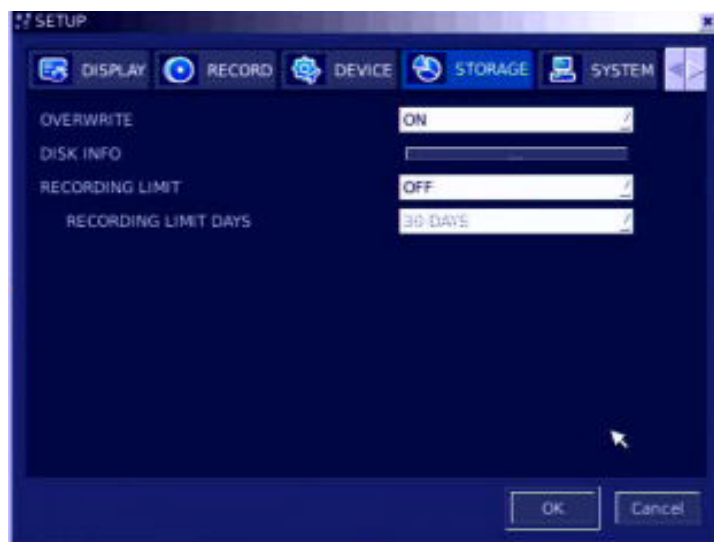
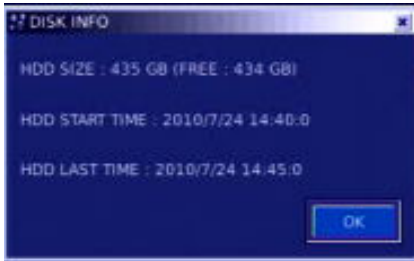

Figure 2.5.1. STORAGE setup screen

Table 2.5.1. Menu items in STORAGE Setup screen

Item	Description
OVERWRITE	When enabled, the DVR will continue recording and overwrite the oldest existing recorded data once the hard drive is full. When disabled, recording will stop once the hard drive is full.
DISK INFO	Hard drive information 
RECORDING LIMIT	Enable/disable recording limit.
RECORDING LIMIT DAYS	Set the recording limit days.(1- 90 days)

*** HDD Format***

: In order to use HDD format then go to Test Mode.

- How to go to the test mode?
- Go to Security Mode and Select User Password

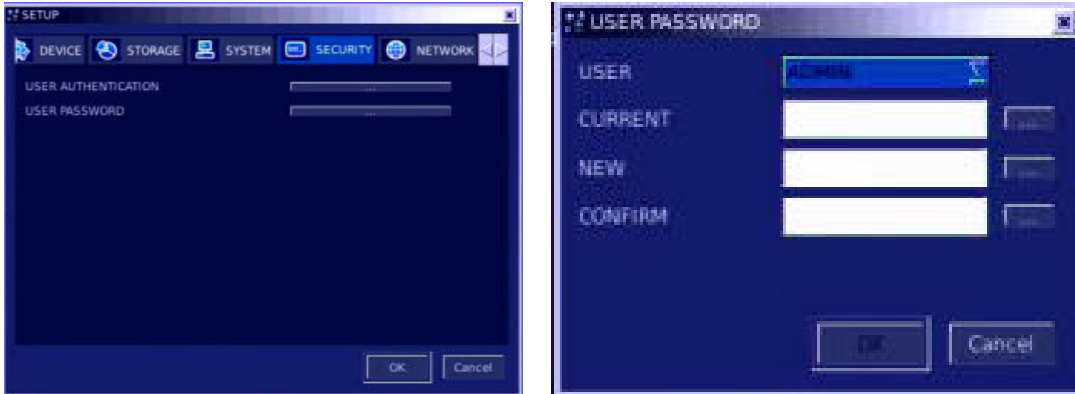

- Select Admin
- Put the password at the Current blank by remote controller or virtual keyboard
- Put this "12341234" number and push the OK button

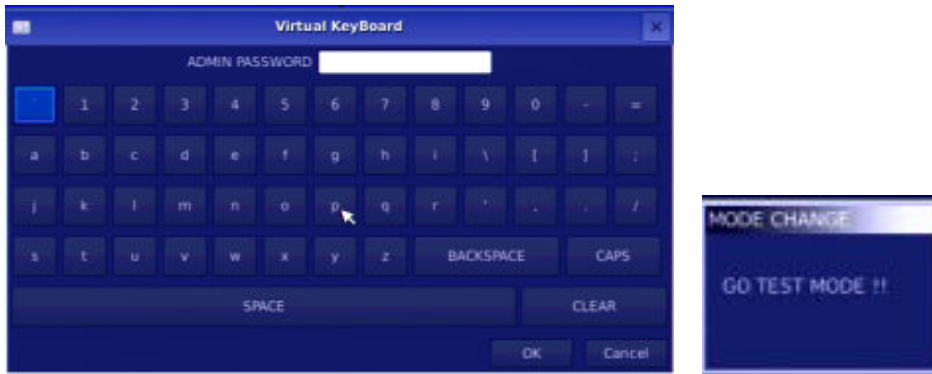

- Go to Test Mode and DVR will reboot

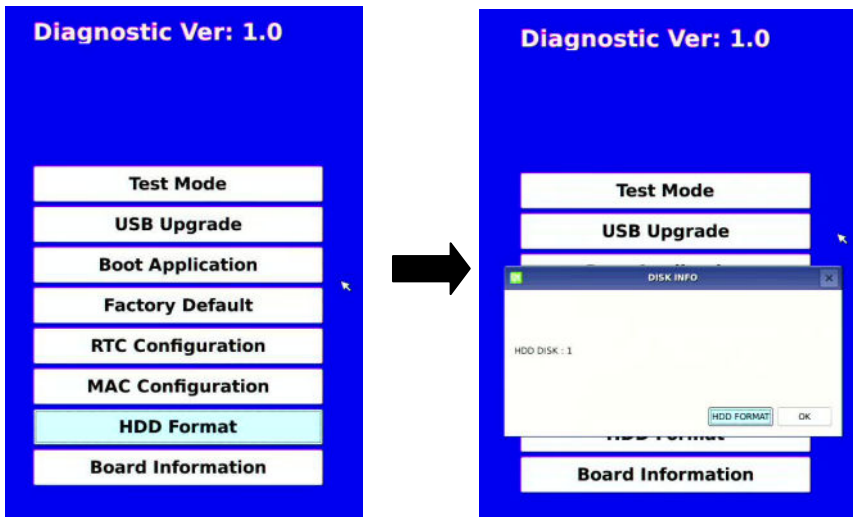

2-6. Setup – System Mode

Press the SETUP button and enter the password. The setup menu is displayed as picture below. Select SYSTEM icon and press SEL button to enter the menu item. Navigate through the menu items using the control button (◀ ▲ ▶ ▼) and change the value of the menu item using the control button (◀ ▲ ▶ ▼). To return to setup menu screen, press the ESC button.



Figure 2.6.1. SYSTEM Setup Screen

Table 3.6.1. Menu items in SYSTEM Setup screen

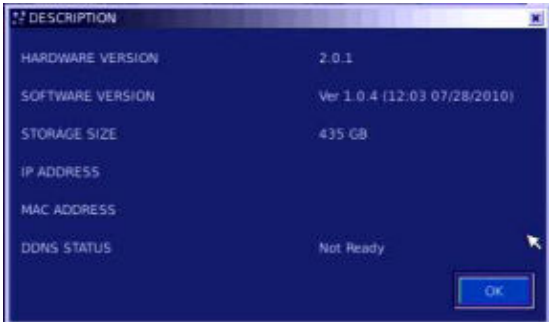
Item	Description
DVR ID	Press the SEL button and select DVR ID using the control button (◀ ▲ ▶ ▼), and press SEL button. Press OK to apply the selected DVR ID. SPACE / Caps Lock(Select either Capital or Lower letter) BS(Back space: Erase previous character) / Clear(Erase all characters)
DESCRIPTION	Press SEL button to view system information. (Hardware version, Software version, Storage size, IP address and MAC address.)
	
LANGUAGE	Select the display language using the control button (◀ ▲ ▶ ▼). Once a language is selected, the display language changes.
DATE FORMAT	Select the date display format using the control button (◀ ▲ ▶ ▼). Options are: YYYY/MM/DD MM-DD-YYYY DD-MM-YYYY
SET DATE&TIME	Move the cursor to the display date and time using the control button (◀ ▲ ▶ ▼) and press SEL button to set the present date and time. Press ESC button to return to SET DATE & TIME setup menu.



CLIENT ACCESS	Enable/Disable remote access through network client software.
BANDWIDTH SAVING	Enable/Disable only key frame transmission. "ON" mode is favorable for use of low network bandwidth. Mostly, set "OFF" for normal use.
NTP	NTP is an abbreviation for Network Time Protocol, which is for synchronizing the clocks of computer systems over variable-latency data networks.

PRIMARY SNTP SERVER: Input the address of the primary NTP time server.

SECONDARY SNTP SERVER: Input the address of the secondary NTP time server.

TIME ZONE: Greenwich Mean Time(GMT) is a term originally referring to mean solar time at the Royal Observatory, Greenwich in London. Because NTP synchronizes with Greenwich Mean Time(GMT) regardless of geography, users must set their own time difference. (Ex.KOREA GMT+09:00)

CONNECTON MODE: Select NTP time server connection mode.

CONNECTION PERIOD: 1~24

2-7. Setup – SECURITY Mode

Press the SETUP button and enter the password. The setup menu is displayed as picture below. Select SECURITY icon and press SEL button to enter the setup menu item. Navigate through the menu items using the control button (◀ ▲ ▶ ▼) and change the value of the menu item using the control button (◀ ▲ ▶ ▼). To return to setup menu screen, press the ESC button

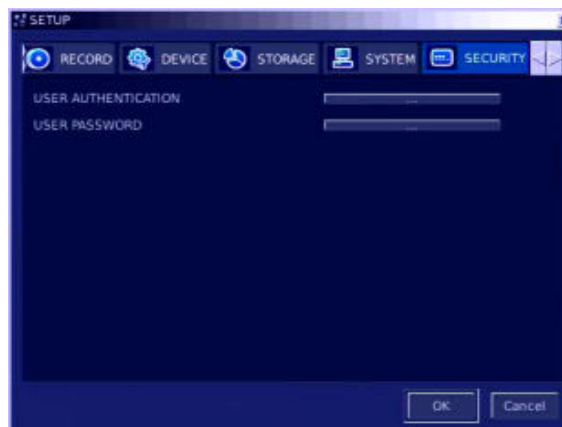

Figure 3.7.1. SECURITY setup screen

Table 2.7.1. Menu Items in SECURITY Setup Screen

Item	Description
------	-------------

USER AUTHENTICATION

PASSWORD CHECK:

Check either V or blank for the functions such as **Setup, Playback(PB), PTZ, Record OFF(R/OFF), and Network.**
 V: Ask for a password when the given function is selected for all users.
 Blank: Does not ask for a password when the given function is selected for all users.

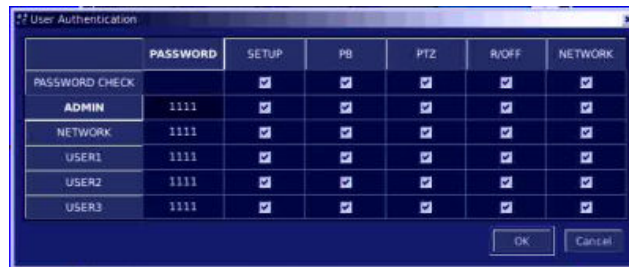

USER PASSWORD

ADMIN, NETWORK, USER1, USER2, USER3:

Options are ADMIN, USER1, USER2 and USER3.
 Select USER PASSWORD using control button (◀ ▲ ▶ ▼) and press SEL button. Select user type using the control button (◀ ▲ ▶ ▼) and SEL button. Enter the current password and select OK. Enter the new password and select OK. Enter the same password again to confirm and select OK. Then the message “PASSWORD CHANGED” is displayed.
 The factory default password is **1111**.

2-8. Setup – Network Mode

Press the SETUP button and enter the password. The setup menu is displayed as picture below. Select NETWORK icon and press SEL button to enter the setup menu item. Navigate through the menu items using the control button (◀ ▲ ▶ ▼) and change the value of the menu item using the control button (◀ ▲ ▶ ▼). To return to setup menu screen, press the ESC button

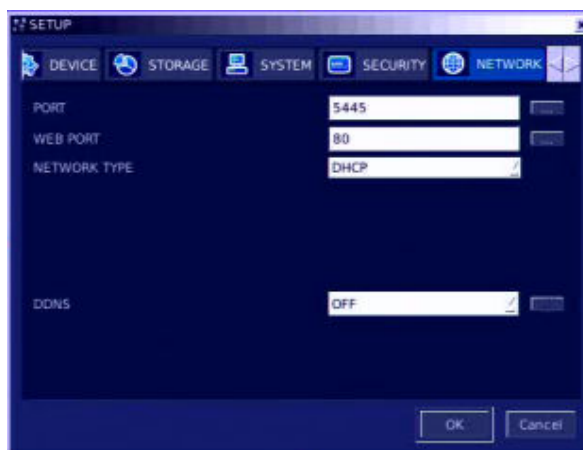

Figure 3.8.1. NETWORK setup screen

Table 3.8.1. Menu items in Network Setup screen

Item	Description
PORT	Port number (Default: 5445)
WEB PORT	Web Sever Port number
NETWORK TYPE	Select a type of network connection. Options are: DHCP and STATIC Note. Other parts of the network setup screen change depending on what network type you select.
DHCP	DVR automatically get IP varying from time to time from network and does not therefore need to be set.
STATIC	Assigned to an Internet service provider (ISP) to be its permanent address on the Internet.
DDNS	Enable/disable using domain name address through DDNS server. “ON” mode, DDNS server name appears for domain registration. DDNS SERVER NAME: The DDNS sever name is bestddns.com. CAUTION: Do not change this sever name. If this is changed, the DDNS service cannot be available. DDNS INTERVAL: Set the connection interval (5-60minutes)

2-8-1. Ports

When you connect one or more DVRs to a network through an IP sharing device, each device must have a unique TCP port number for access to each unit from outside the LAN. Also, the IP sharing device must be configured for port forwarding so when each port is accessed on the IP sharing device, it will forward to the appropriate DVR.

Note: This port number is listed next to the Port menu option in the Network Setup screen. If you plan to access the DVR units only from within the same LAN, the TCP port does not have to be changed.

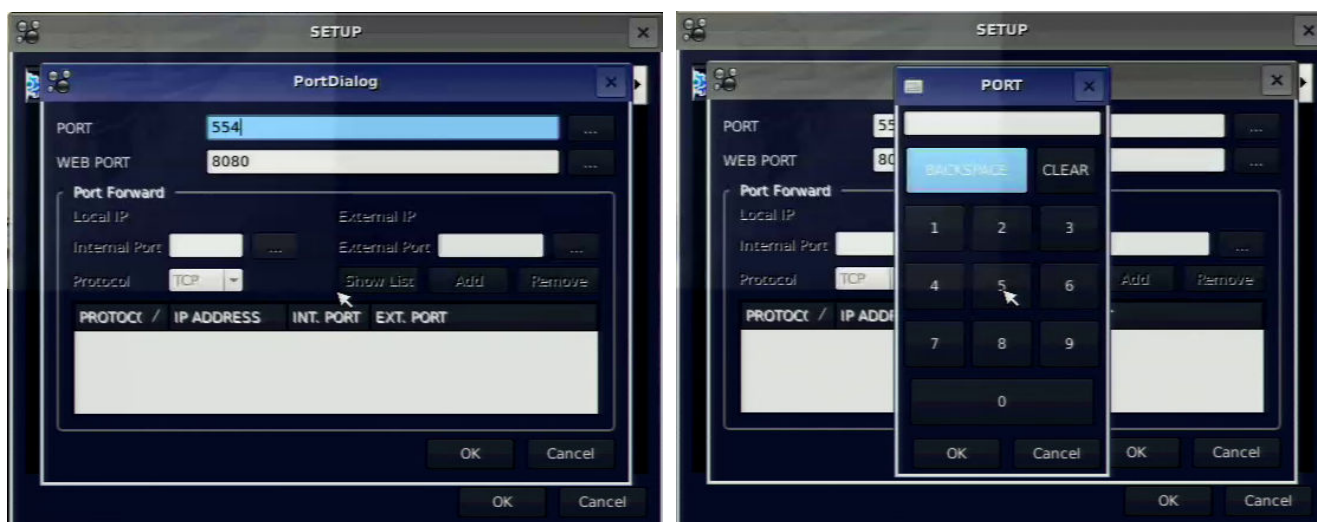

Figure 3.8.5. Network setup screen – Network Port

Network access beyond a router

In order to access the DVR remotely beyond a router (firewall), the user must open TCP port for command level, live channels and storage channels. User need to open 2ports numbers.

If the DVR port number is set to 5445, open the TCP port 5445 and 5446 on the router.

If this port is not opened properly, user can not access DVR beyond a router.

If dvr supports remote setup function over the network, user need to open additional port 5455 which is the 10th number from the basic port number.

Web viewer Network access beyond Router

In order to access beyond Router (Firewall), user must open 1 TCP port that is set on NETWORK > WEB PORT. If this port is not open properly, user can not access DVR using direct Web viewer.

(Example: When NETWORK > WEB PORT is set as 80, 80 TCP port of IP address of DVR must be open.)

2-8-2. Network Types

2-8-2-1.STATIC

1. For the use of fixed IP.

(See your network administrator if you do not have this information.)

2. When DVR is installed in IP sharer that is connected with ADSL, a user can assign fixed IP to DVR from IP sharer itself using “DMZ” function out of such sharer.

Input IP set in DMZ on “IP” field and Gateway of ADSL modem on “Gateway” field. Similarly, for Subnet Mask, DNS address, input relevant values in IP sharer.

Table 3.8.2. LAN

Item	Description
IP	The fixed IP address of the DVR unit.
SUBNET MASK	The subnet mask for the LAN
GATEWAY	The IP address of the Gateway
1st DNS	The address for the DNS server
2nd DNS	The address for the DNS server

2-8-2-2. DDNS

User can use the function to connect to a network with a domain name. When it selects a Sever 1, user can select one type among three DDNS Servers which be supporting for free. (okddns.com for Korea, ddnscenter.com for USA and bestddns.com for other area including EU) The DDNS interval can be set from 5 to 60 minutes. To connect to a network with a domain name, user also has to register a MAC address and create a unique domain name to <http://www.bestddns.com>, <http://www.okddns.com> or <http://www.ddnscenter.com>. Please refer to page 90 for the detail of the registration.

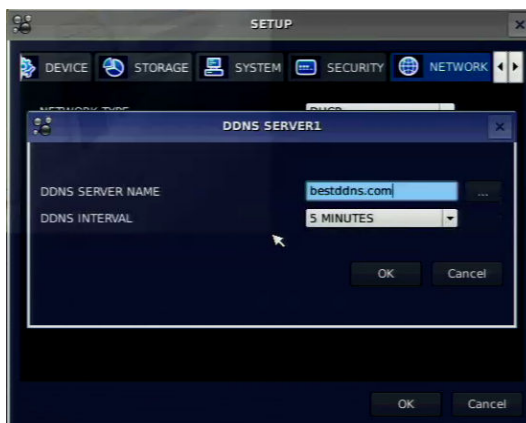

Figure 2.8.4. Network setup screen – DDNS Server 1

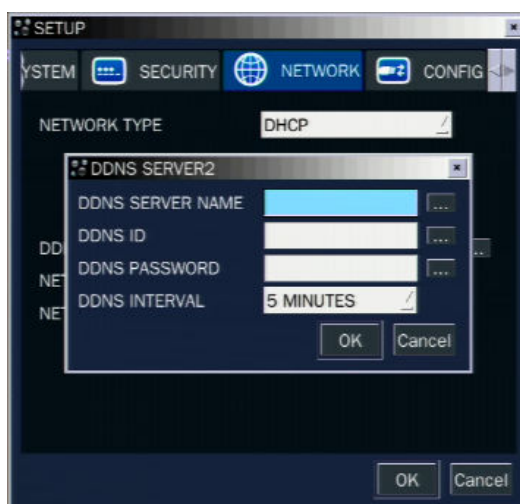

Figure 2.8.5. Network setup screen – DDNS Server 2

If user wants to use other general-purpose DDNS Server, select a Sever 2. Then, user has to input the server name, ID and password using a virtual keyboard.

2-8-2-3. DHCP

An IP address is automatically assigned by the DHCP server, which automatically assigns IP address and other parameters to new devices.

When ADSL or other network being used adopts variable IP method, not fixed IP. This option is used as a way to automatically get IP address.

2-9. Setup - CONFIG Mode

Press the SETUP button and enter the password. The setup menu is displayed as picture below. Select CONFIG icon and press SEL button to enter the setup menu item. Navigate through the menu items using the control button (◀ ▲ ▶ ▼) and change the value of the menu item using the control button (◀ ▲ ▶ ▼). To return to setup menu screen, press the ESC button

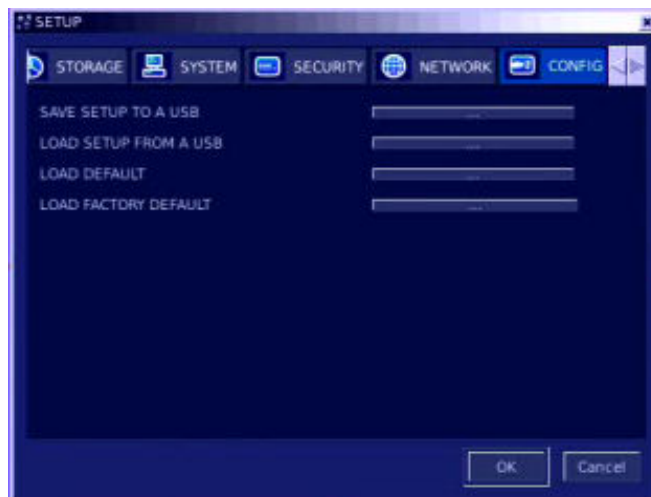

Figure 2.9.1. Config setup screen

Table 2.9.1. Config setup

Item	Description
SAVE SETUP TO A USB	User can save the current configuration (Setting values) of DVR to the USB memory stick. Put the USB stick on the front panel and press SEL to start the saving process.
LOAD SETUP FROM A USB	User can upload the configuration of DVR to another DVR using the USB Memory stick. Put the USB stick on the front panel and press SEL to start the loading process.
LOAD DEFAULT	Select ON to reset the system to the default settings. (The follow settings such as Language, DVR ID, Security User Authentication, Security User P/W, Date format, DLS settings, Network settings, HDD serial number, and HDD ERROR time will not be included.)
LOAD FACTORY DEFAULT	Select ON to reset the system to the factory default settings.

3. Saving Setup

To preserve the setup values that you have changed, select YES.

4. Live, Search, and Playback







4-1. Live Viewing Screen

In the Live screen, video inputs from the cameras are displayed as they are configured in the Display Setup screen. Various on-screen display (OSD) symbols, which indicate the status of the DVR, are described in Table 5.1.1.



Figure 4.1.1. Live Viewing Screen

Table 4.1.1. Status Indicator Icons in Live Viewing Screen

Icon	Description
	Click the power icon when you want to shut it off by mouse
	Click the LOCK icon when you want to lock and unlock the DVR by a mouse
	Click the SETUP icon on the screen using the mouse to see menu items. Select menu item (SETUP, SEARCH, BACKUP, RECORD, PTZ, SEQUENCE, AUDIO or ALARM-OUT) using the mouse to enable/disable its functions
	Click the AUDIO icon when you want to activate the audio using a mouse
	Click this SEARCH icon when you want to play back and search from the recorded data using a mouse
	Click this BACKUP icon when you want to back up from the recorded data to USB Memory Stick

















	Click this PTZ icon when you want to control the PTZ cams using a mouse
	Click this SEQUENCE icon when you want to activate the sequential screen
	Click this MANUAL RECORD icon when you want to manually record
	Click this ALARM OUT icon when you want to activate alarm out
	Click the split screen icon to change the current split screen mode using the mouse or SEL button.
	Displays the current date and time
	Remote control ID display. If no remote ID is set the message "ALL" is displayed.
	Displays the amount of recording on the hard disk from 0-100%.
	Indicates that lock activated, this icon will be back to black color when unlock.
	Indicates that alarm is set. To set the alarm function, press the Alarm button on the front panel.
	Indicates that alarm output is activated.
	Mixed audio display
	Alarm indicator. When there is an alarm (sensor or motion alarm) in the video channel, this icon will be highlighted bright blue.
	Indicates that a network client is connected to the DVR.
	Indicates that sequencing mode is enabled.

Table 4.1.2. Button functions in Live Viewing Screen

Button	Description
	Select channel to be displayed in full screen mode.
	Switch between full screen and quad display mode.

SEQ	Press to start auto sequencing of the screen in full screen mode. (Toggle)
RECORD	Press to start and stop manual recording.
SEARCH	Press to go to the search menu. Event search /Time line search /Log /Archive search
ARCH	Press to capture a still image. The still image will be stored into hard drive. It can be transferred to the USB device.
SETUP	Press to launch SETUP menu.
ESC	Press for temporal storage of the changed value or to return to the previous menu screen.

4-2. SEARCH Screen

To enter the search screen, select MENU and SEARCH on the screen using the mouse or press SEARCH button on the front panel in live mode.

When you press the SEARCH button, DVR asks for a password as in Figure 5-2-1.

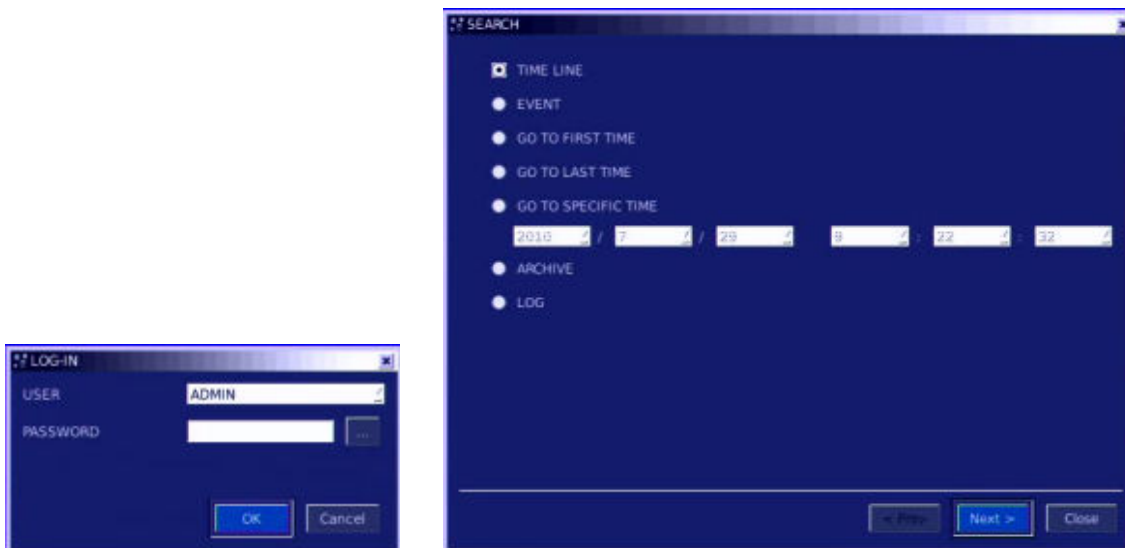
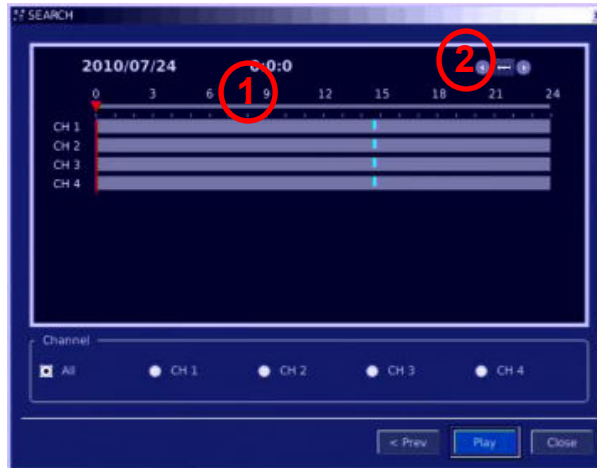

Figure 4.2.1. Search Screen

Enter the password using the control button (◀ ▲ ▶ ▼).

There are 7 ways of search menu such as TIMELINE, EVENT, GO TO FIRST TIME, GO TO LAST TIME, GO TO SPECIFIC TIME, LOG, and ARCHIVE on the screen.

How to search data on the time line using the mouse or front key button



① 1 hour moving: 1-hour time bar(Mouse)/ F/REW and F/ADV button(Front key)

② 5 minute moving: ◀ 12:00:00 ▶(Mouse)/ control button ◀ ▶(Front key)

4-2-1. TIME-LINE Search

The TIME-LINE search window is used to find the stored video by using the time line bar.

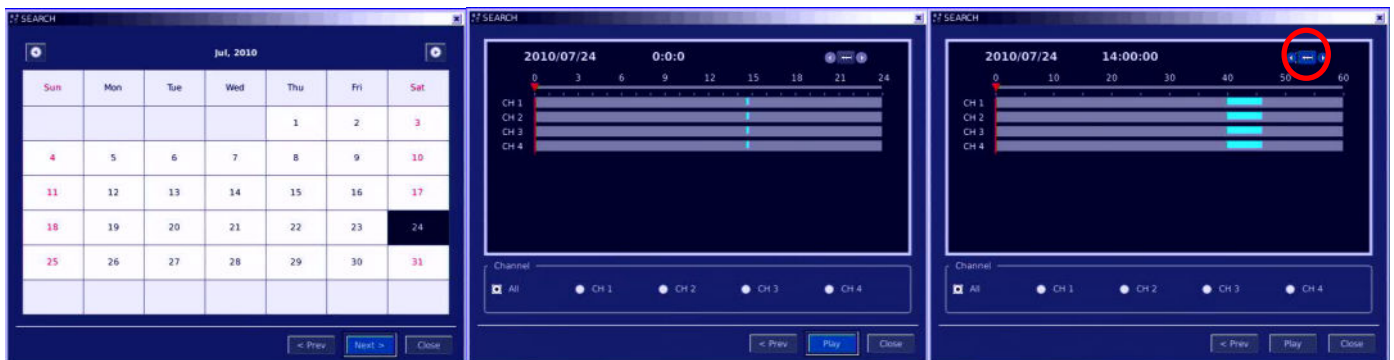

Figure 4.2.2. Time-line Search

1. Select the date of the video to begin searching and navigate through the days using the control button (◀ ▲ ▶ ▼).
2. Once you have selected the date, press the SEL button to move to the time line search window.
3. Use the control button (◀ ▲ ▶ ▼) to select a time zone on the 24 hours time table.
4. Select All or a specific channel to search video clip on the time line bar using the control button (◀ ▲ ▶ ▼).
5. Once you select the channel, use the control button (◀ ▲ ▶ ▼) to move to the point you wish to start playing the video clip.
6. Once you have selected the time zone, press the SEL button to playback the recorded video.
7. Press the ESC to return to the SEARCH window.

4-2-2. Event Search

The Event Search window is used to find stored video. Three categories of search filters can be applied: DATE, CHANNEL and TYPE. Press SEL to select a value and move down to the next category and use the control button (◀ ▲ ▶ ▼) to move up to the categories you have previously entered. The ESC button will return the user to the previous screen.

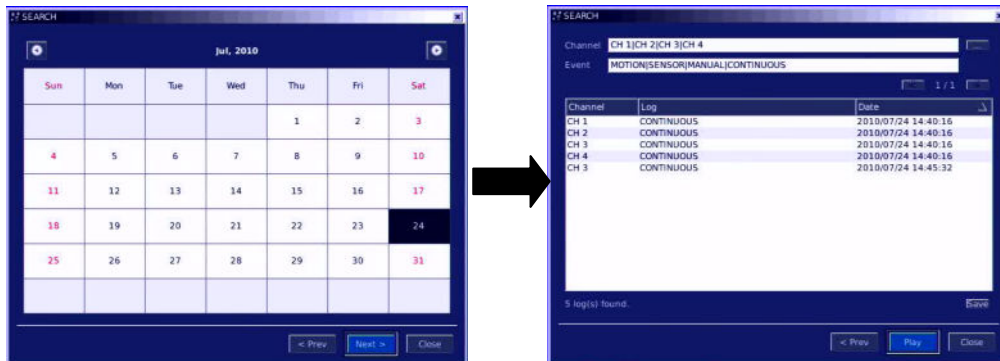

Figure 4.2.3. Event Search screen

1. Select the date of the video to begin searching. Use the control button (◀ ▲ ▶ ▼) to navigate through the days.
2. Once you have selected the date, press SEL to move to the CHANNEL selector.
3. Use the control button (◀ ▲ ▶ ▼) to change the channel selection from ALL to any of the available channels.
4. Once you have selected the channel, press SEL to move to the TYPE selector.
5. Use the control button (◀ ▲ ▶ ▼) to change the type of recording to ALL, MOTION, SENSOR, MANUAL, or CONTINUOUS.
6. Once you have selected the type of recording to search for, press SEL to produce a list of instances that fit your search criteria.
7. Use the control button (◀ ▲ ▶ ▼) to scroll through the on-screen listings.
8. Use the control button (◀ ▲ ▶ ▼) to display a list of events that happened previous to or after the current selection.
9. Once the desired event has been selected, press SEL to start playing back the selected video.
10. Press the BACKUP button to launch the archiving function in playback mode.
11. Press the ESC to return to the SEARCH window.

4-2-3. Go To First Time

You can access the oldest recorded data on the DVR hard drive by selecting GO TO FIRST TIME on the SEARCH window. Press the ESC to return to the SEARCH window.

4-2-4. Go To Last Time

You can access the latest recorded data on the DVR hard drive by selecting GO TO LAST TIME on the SEARCH window. Press the ESC to return to the SEARCH window.

4-2-5. Go To Specific Time

You can search for video data from a specific instance by setting the date and time in the GO TO search window. Use the control button (◀ ▲ ▶ ▼) to move through the date and time values in this menu. Use the control button (◀ ▲ ▶ ▼) to change the date and time value. Move the cursor to OK using the control button (◀ ▲ ▶ ▼) and press the SEL to playback the recorded video.

4-2-6. Log Search

You can access the LOG list search screen by selecting LOG on the SEARCH window.

Select a date using the control button (◀ ▲ ▶ ▼) and press SEL to open the LOG list from that date.

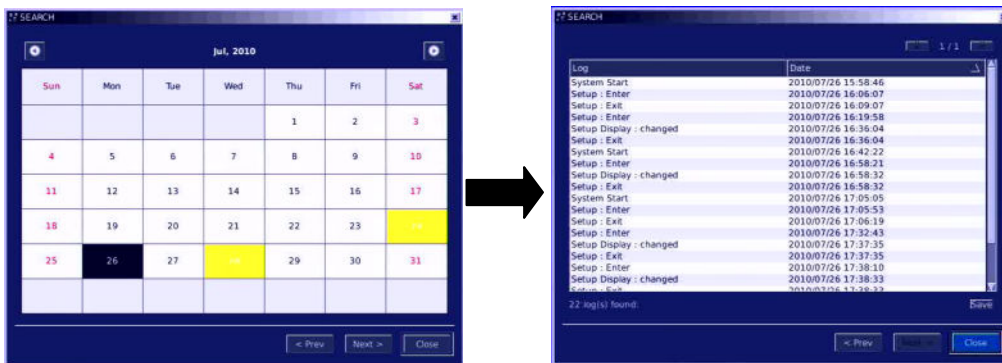

4-2-7. Archive Search

The ARCHIVE Search window is used to find previously stored video or images.

1. Select the date to begin searching and navigate through the days using the control button (◀ ▲ ▶ ▼).
2. Once you have selected the date, press SEL to open the list of stored data.
3. Use the control button (◀ ▲ ▶ ▼) to scroll through the on-screen listings.
4. Use the control button (◀ ▲ ▶ ▼) to display a list of stored events that happened previous to or after the current selection.
5. Once the desired event has been selected, press SEL to view the still image or the first frame of the selected video.
6. Press the BACKUP button to launch the archiving function in playback mode.
7. Press the ESC to return to the SEARCH window

4-3. Play mode

During playback of a recorded event, the mode changes from SEARCH to PLAY. While in PLAY mode, you may return to the SEARCH screen by pressing the ESC button.



Figure 4.3.1. PLAY Mode Screen

Table 4.3.1. Button functions in PLAY Mode

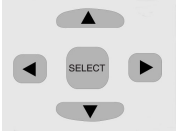
Button	Description
ESC	Return to the previous menu screen, search list, or exit menu
◀◀ REW	Press to rewind the footage at 1x, 2x, 4x, 8x, 16x and 32x speeds. Reverse playback speed is shown as REW 1x, 2x, 4x, 8x, 16x and 32x at the bottom right of the screen.
◀◀ F/REW	Jump/Step backward. – The playback position moves 60 seconds backward.
PLAY/PAUSE	Press to play or pause recorded video.
F/ADV ▶▶	Jump/Step forward –Playback position moves 60 seconds forward.
FF ▶▶	Press to fast forward the footage at 2x, 4x, 8x, 16x and 32x speeds. Playback speed is indicated as FF 2x, 4x, 8x, 16x and 32x at the bottom right of the screen.
	UP: 1CH, RIGHT: 2CH, DOWN: 3CH, and LEFT: 4CH to be highlighted UP: NO. 1, RIGHT: NO. 2, DOWN: NO. 3, and LEFT: NO. 4CH to input password
ARCH	Press the ARCH button to archive the video into HDD.

5. PTZ Control

To control the PTZ functions of the camera, select MENU and PTZ on the screen using the mouse or press the PTZ button on the front panel.

Select the item you wish to control the PTZ camera and control them using the control button (◀ ▲ ▶ ▼). Please refer to the table 6.1.1. for the control.

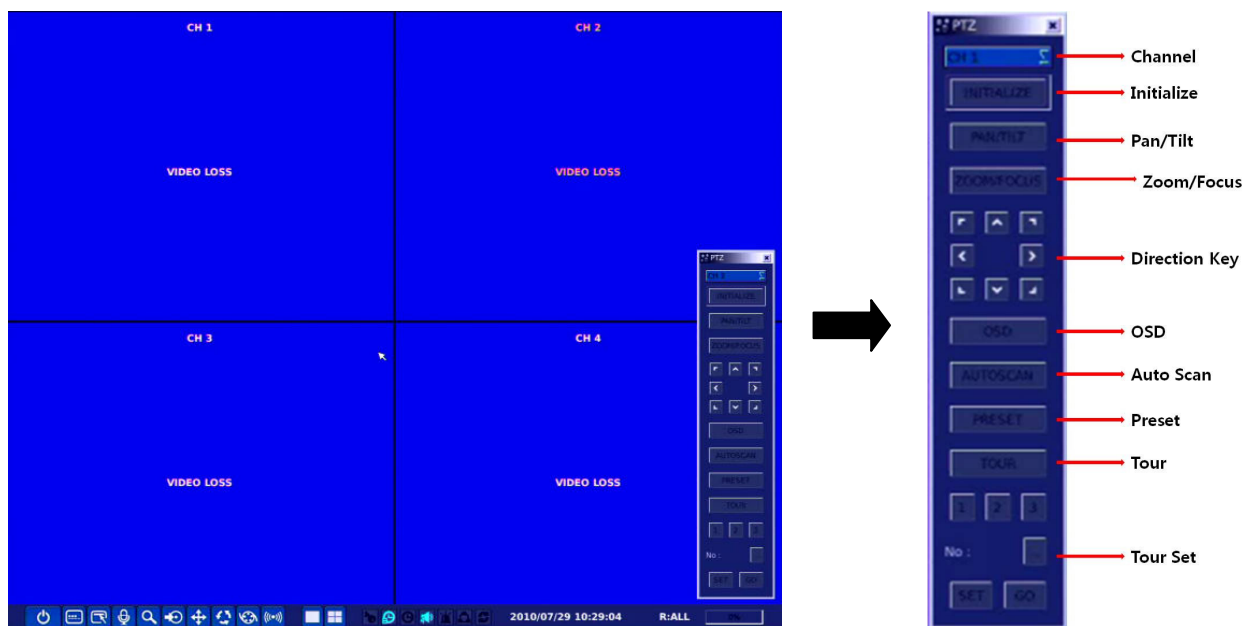

Figure 5.1.1. PTZ Control Screen

Table 5.1.1. Button Functions in PTZ Control

Item	Description
PAN / TILT	Select PAN/TILT using the control button (◀ ▲ ▶ ▼) and press SEL button. Adjust the tilt(UP/DOWN)/pan(LEFT/RIGHT) position using the control button (◀ ▲ ▶ ▼).
ZOOM / FOCUS	Select ZOOM/FOCUS using the control button (◀ ▲ ▶ ▼) and press SEL button. Adjust the zoom(UP/DOWN)/focus(LEFT/RIGHT)position using the control button(◀ ▲ ▶ ▼).
INITIALIZE	Initialize the PTZ settings of the selected camera.
PRESET	Select the PRESET and press the left key (◀) on the control button. Then, number input window will appear. Set the number (3 digits) using the number key and press the SEL to set the preset number for the current position. Press the right key (▶) on the control button and set the number (3 digits) to go to the preset number.
TOUR	Select the TOUR and press the right key (▶) on the control button. Then, number input window will appear. Set the number (1 digit) using the number key and press SEL to make the group number work. Press the left key (◀) on the control button to stop tour. User can set the preset number in the tour group of the OSD menu.
OSD	Select the OSD to enter the menu. Control keys are Right, Left, UP, Down, Select, Far (REW KEY), and Near (FF KEY). Press the ESC button to return to the main menu. Press the PTZ button to escape from the OSD menu.
AUTOSCAN	Press the right key (▶) on the control button to start auto scan

	Press the left key (◀) on the control button to stop auto scan.
PTZ	Press the PTZ button to escape from the OSD menu.
ESC	Press the ESC button to return to the main menu.
NUMBER	Available only on the TOUR and PRESET menu.

- **Preset/ Tour/ OSD/ Autoscan function are available on the specific model AP8777 and PMA-200.** (Select it in the NAME of PTZ setup menu)

Table 5.1.2. Description of RS-485 port

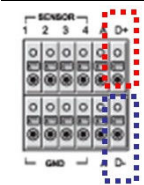
	RS-485: D+	Data +
	RS-485: D-	Data -

6. Back up

6-1. Still Image backup onto USB flash memory

Still images can be captured and archived onto the USB stick, hard drive in live mode or while playing back recorded video.

In live mode, press the BACKUP button to launch the archive function or select MENU and BACK UP on the screen using the mouse.



Figure 6.1.1. Still Image Archiving and Backup Screen

1. When you press BACKUP button, the archiving screen will display as Figure 7.1.1.
2. And the DVR will ask which media you will take for archiving.
3. Once you select the media, the system will start to archive the data to the selected media.

6-2. Video backup onto USB flash memory

Video can be captured and archived onto the USB stick, hard drive while playing back recorded video. In playback mode, press the BACKUP button to launch the archiving function.

1. When you press BACKUP button, the DVR will ask whether to archive a Still Image or Video clip.
2. If the user selects VIDEO, the DVR will ask which media you will take for archiving.
3. If the user selects VIDEO, the DVR will ask for the setting of the archiving duration.
4. Once you select the media, the system will start to archive the data to the selected media.

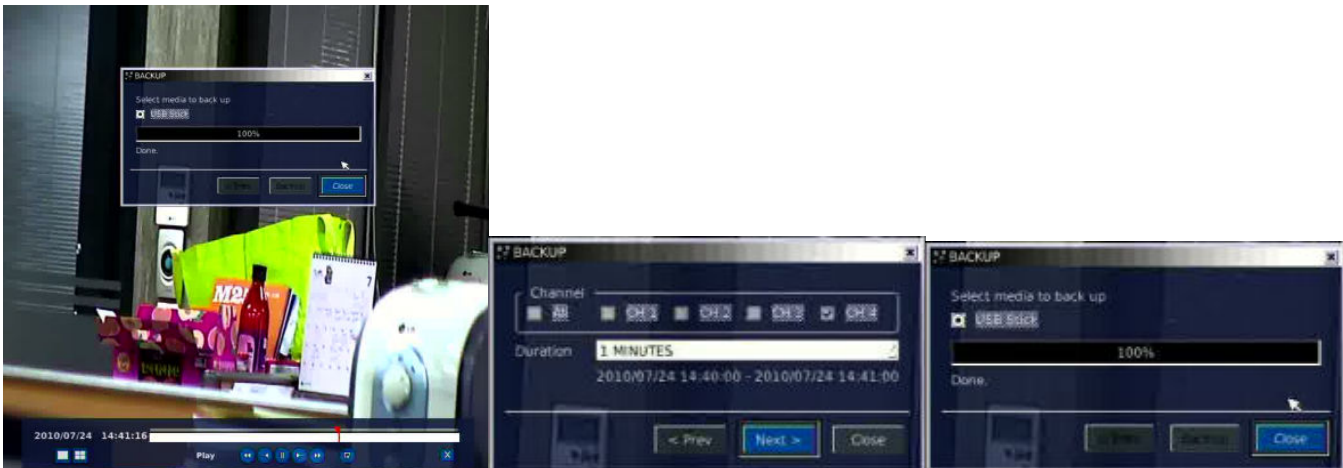

Figure 6.2.1. Video Archiving and Backup Screen

The DVR will convert the corresponding portion of the video into an AVI file.

6-3. Transferring still images or video from the ARCHIVE list

The stored data onto hard drive will be found in the ARCHIVE list in SEARCH window.

User can back up still images or video into the storage device from the ARCHIVE list.

1. Select the date to begin searching and navigate through the days using the control button (◀ ▲ ▶ ▼).
2. Once you have selected the date, press SEL to open the list of stored data.
3. Use the control button (◀ ▲ ▶ ▼) to scroll through the on-screen listings.
4. Select a list of stored events that happened previous to or after the current selection.
5. Once the desired event has been selected, press SEL to view the still image or the first frame of the selected video.
6. Press the BACKUP button to launch the archiving function in playback mode.
7. Press the ESC to return to the SEARCH window.

6-4. Playback of Backup Video

- **NSF format:** NSF format video can be played back by the player (the DVR player) that the DVR copies on USB thumb drive with video. Two files are copied on USB thumb drive
 - NSF file: NSF format video file.
 - PLAYER: Exclusive video viewer.
- **AVI format:** This format is not support from DVR but this format is possible to make throw the DVR

player by converting.

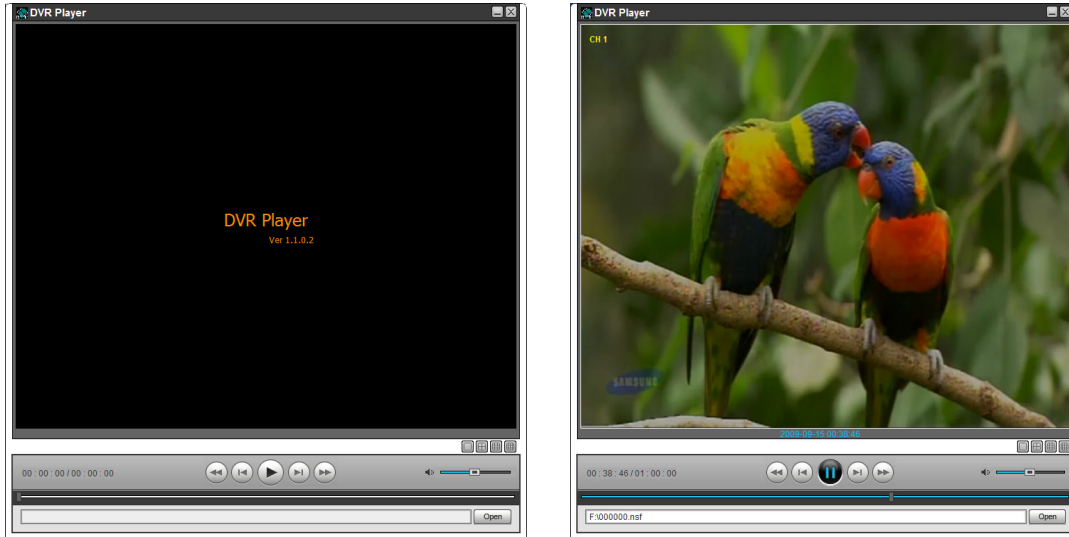

7. Upgrading Firmware

In order to upgrade, the firmware upgrade file must first be downloaded and copied into the USB memory stick. Create a new folder in the USB memory stick and name it “upgrade”. Copy the firmware upgrade file “apph_XXXXXX.bin” into the “upgrade” folder.

NOTICE

The folder on the USB memory stick must be named **“upgrade”**.

After the firmware upgrade file is copied into the USB memory stick, connect the USB memory stick to the USB port on the front panel and do the followings:

1. Press the SETUP button and enter the admin password.
2. Go to SECURITY setup menu and USER PASSWORD. Press SEL and select ADMIN using the control button (◀ ▲ ▶ ▼) or use Virtual Keyboard.
3. Enter the password as “12341234”, and press the SEL button.
4. The TEST MODE screen “Diagnostics Vx.xx” will appear.
5. Select USB Upgrade. Then the upgrading will start automatically.
6. After the upgrade is completed, select Boot Application to reboot DVR.

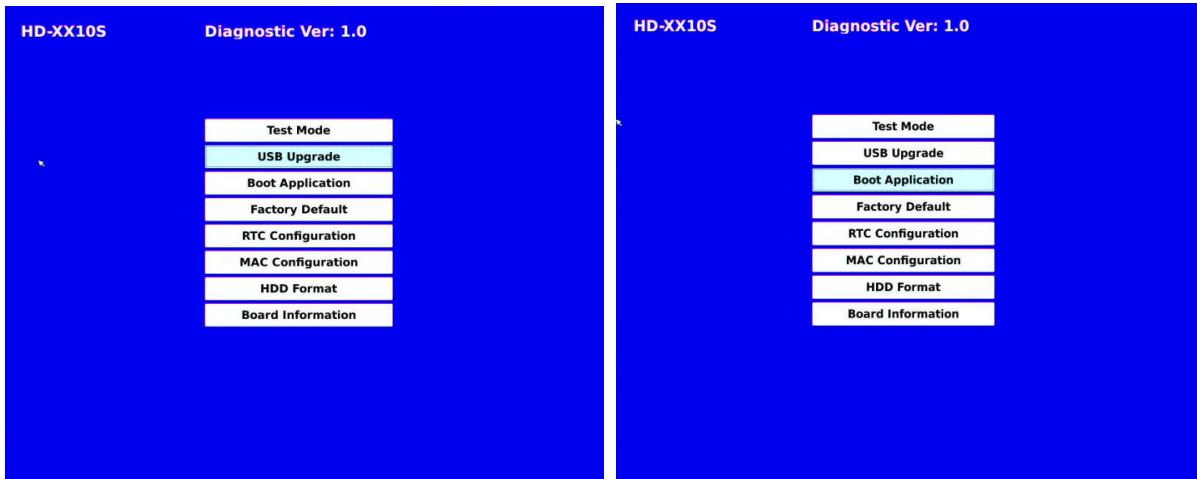

Figure 7.1.1. Engineering mode screen

8. Network access using the UMS Single software

The DVR provides a live remote monitoring feature. Remote monitoring requires installation of the network viewer on your PC.

NOTICE

In a high bandwidth network, a maximum of four users can access one DVR simultaneously. In a low bandwidth network it is recommended that only one user access the DVR at a time.

8-1. PC requirements

- CPU: Intel Pentium IV 1.4Ghz or higher
- Memory: 512MB (1G or higher is recommended.)
- VGA memory: 16MB (64MB or higher is recommended.)
- Resolution: 1024x768
- O/S: Windows 2000, XP Professional, XP home
- Direct X: DirectX 8.1 or higher

8-2. Installing the network viewer

1. Insert the provided CD in the CD drive and double-click "UMSClient(XXXX).exe"
2. Select a destination folder and click "Next". 3. Select the type and click "Next".

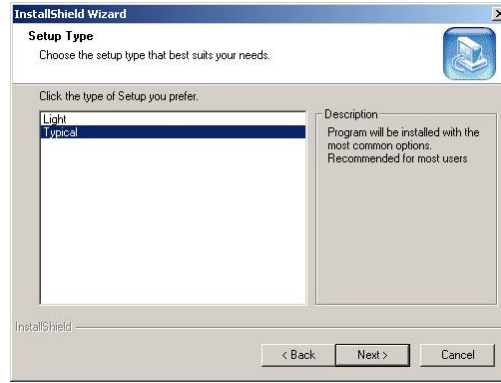
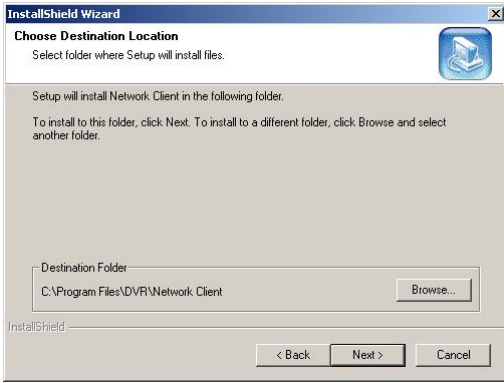

4. Select the program folder and click “Next”.

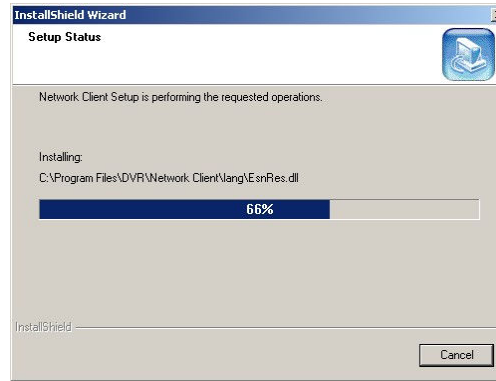
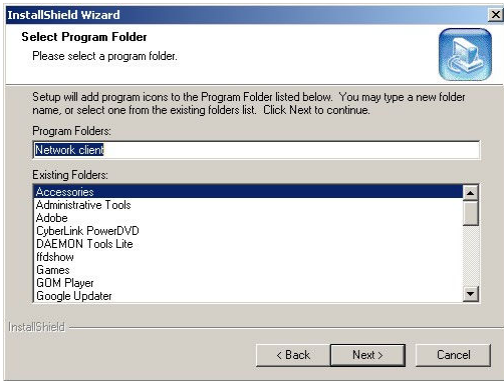

5. The setup status screen is displayed.





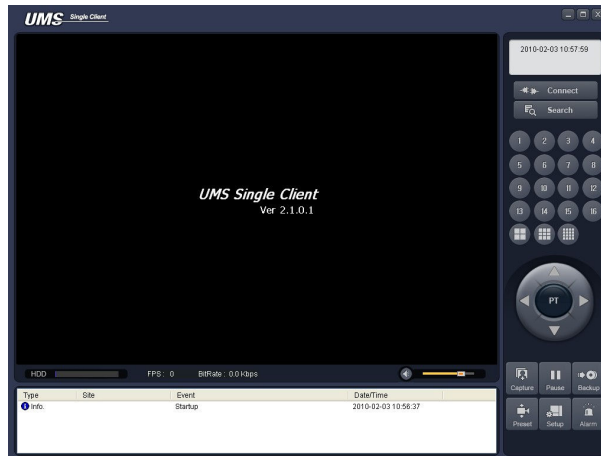

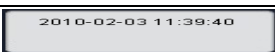

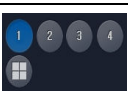

After the installation is completed, “UMS Client”  icon is displayed on the desktop.

8-3. Live monitoring mode and functions.

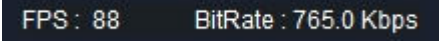

Button	Function	Description
	DATE & TIME	Displays the current date and time.
	CONNECT/DISCONNECT	Connect/disconnect network connection..
	SEARCH	Switches the live mode to search mode.
	DISPLAY MODE	Select a channel and screen display mode.

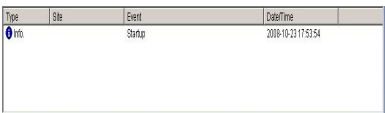
	PAN/TILT/ZOOM/ FOCUS	Control the PAN/TILT/ZOOM/FOCUS features on the remote camera.
	CAPTURE	Capture a still image from live screen.
	PLAY/PAUSE	Play/pause live video.
	ALARM	The ON/OFF button of the alarm output of the DVR. When an alarm of the DVR is output, this button becomes Red.
	SETUP	Display the setup screen of the network viewer.
	HDD USAGE	DVR HDD storage Indicator.
	NETWORK BANDWIDTH	Shows the transferred frames and network bandwidth.
	AUDIO	Adjust the volume. The audio can be turned on or off by clicking the audio icon.
	LOG WINDOW	

Operations of the display mode of the main screen

- Single channel display - Click the one of channel button or double-click the channel screen.



- QUAD/-screen display - Click the QUAD button to switch to quad-screen display

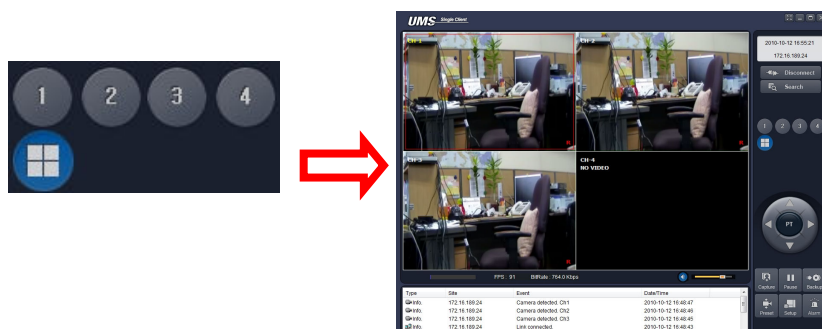

- Full screen display - Click the right button of the mouse and choose the Full Screen button to display only screen and hidden the operation panel.

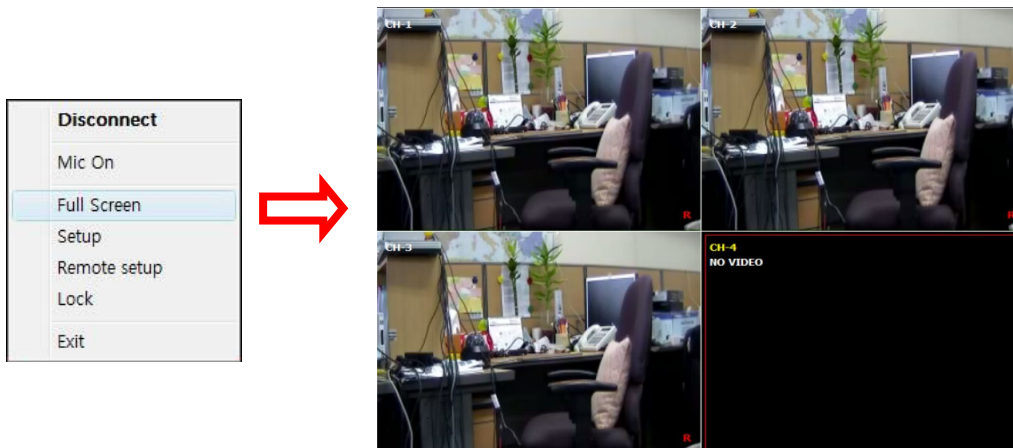
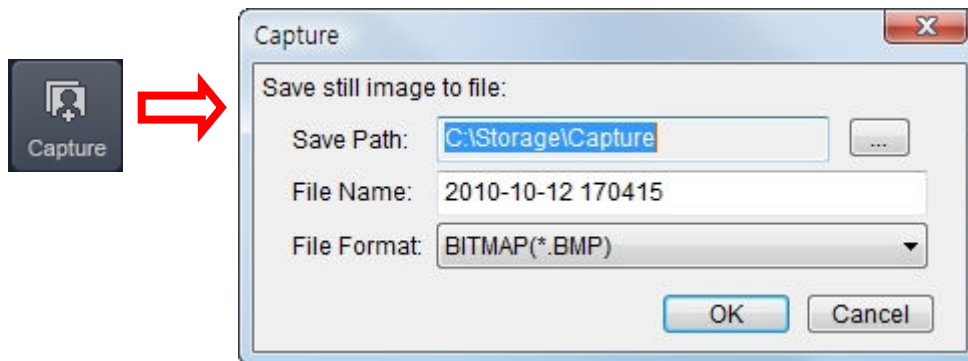

Image capture of live screen

Still-image of live screen can be captured and saved as BMP or JPEG file.

1. Click the channel to be captured. Then the channel screen is surrounded with a red line.
2. Click the CAPTURE button. Then the IMAGE CAPTURE dialog is displayed.







3. Set the conditions and click OK button. Then still-image is saved.

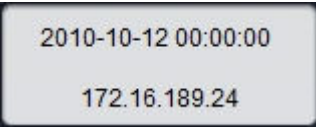
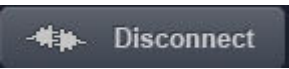

8-4. Bi directional audio

The UMS Client allows for bi directional audio between the client and a dvr unit. On the PC, to use bi directional audio, you will need a sound card of handling a microphone and speakers. On the dvr side, you will need to connect a microphone to the audio in connection, and a pair of amplified speakers to the audio out connection.

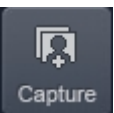
8-5. Remote search mode and functions

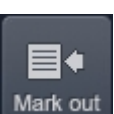
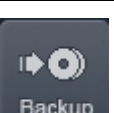

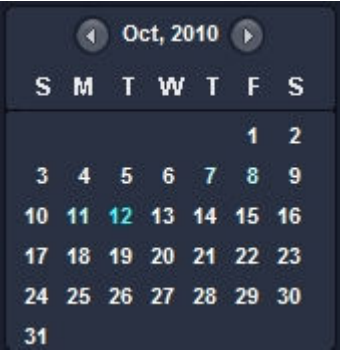
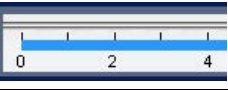
Button	Function	Description
	DATE & TIME	Displays the recording time of the data selected on the time bar at the bottom of the main user interface.
	DISCONNECT	Disconnect network connection..
	LIVE	Switches the search mode to live mode.
	CAPTURE	Capture a still image from live screen.
	MARK IN	Set the start time for video backup.
	MARK OUT	Set the ending time for video backup.
	BACKUP	Backup the selected recorded video as AVI format.

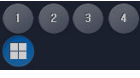
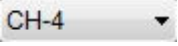
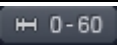
	SEARCH CALENDAR	The calendar shows dates with recorded video in a light blue and the selected date in dark blue.
	TIMELINE BAR	The timeline shows recorded data in dark blue on the bar.
	PLAYBACK BUTTON	The playback buttons.
	DISPLAY MODE	Select a channel and screen display mode.
	CHANNEL SELECT	Show on the screen that you select
	SPECIFIC TIME	Select Specific Time with Hour or Minute

Searching and playing video in the remote DVR

Video recorded in the remote DVR or Video recorded on the PC can be searched and played back.

1. Connect the network to the remote DVR and press SEARCH button. Then the mode is changed from the live mode to the search mode.



- Searching the video recorded in the remote DVR: Connect the network to the DVR..
- Searching the video recorded in the PC: Do not connect the network to the DVR.

2. Select the date to search the video.



3. Drag the slid on the time scale and drop it between 0 and 24.



4. Press the PLAY button. Then the video recorded in the remote DVR is played back per each channel that you choose by HD image..

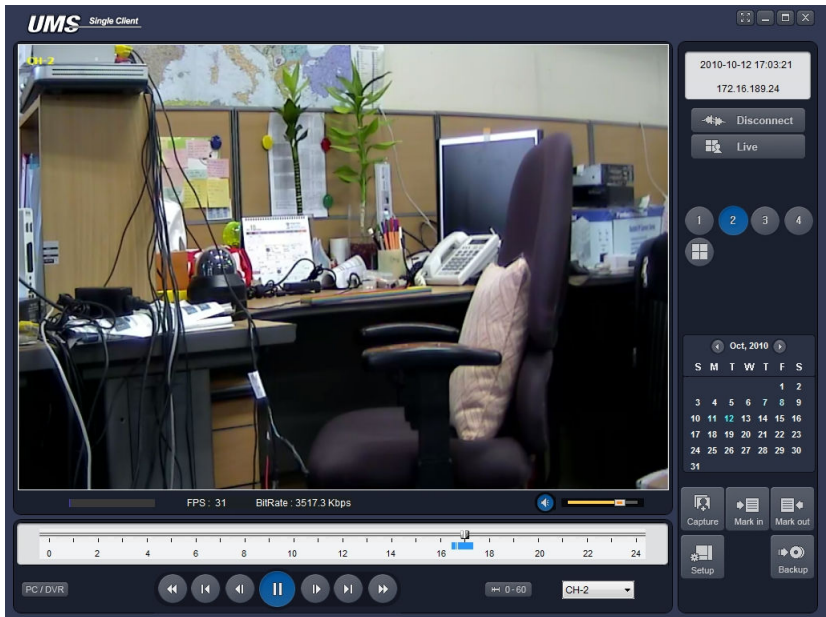

Backup of video in the remote DVR

Video recorded in the remote DVR can be backed up on the PC HDD as AVI format.

1. Connect the network to the remote DVR and play the video recorded in the remote DVR.
2. Drag the slider on the time scale and drop to the start time for video backup and press the MARK IN button.

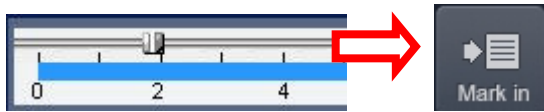

3. Drag the slider on the time scale and drop to the end time for video backup and press the MARK OUT button. Then the marked time is displayed in dark green.



4. AVI Backup dialog is displayed. Click the OK button. Then the marked video is backed up.

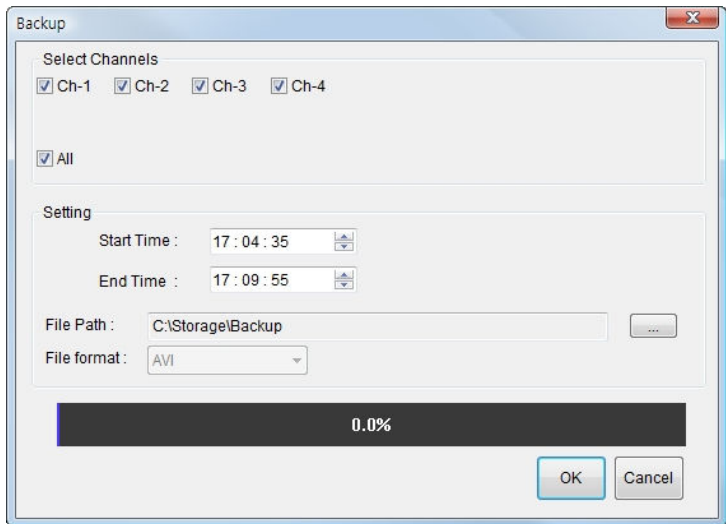

- Start time / Stop time: Backup time can be changed.
- File path: Shows the folder that the backup file is recorded.
- Channel: Shows backup channel..

8-6. PC System configuration

Click the SETUP button. Then the Setup dialog is displayed.

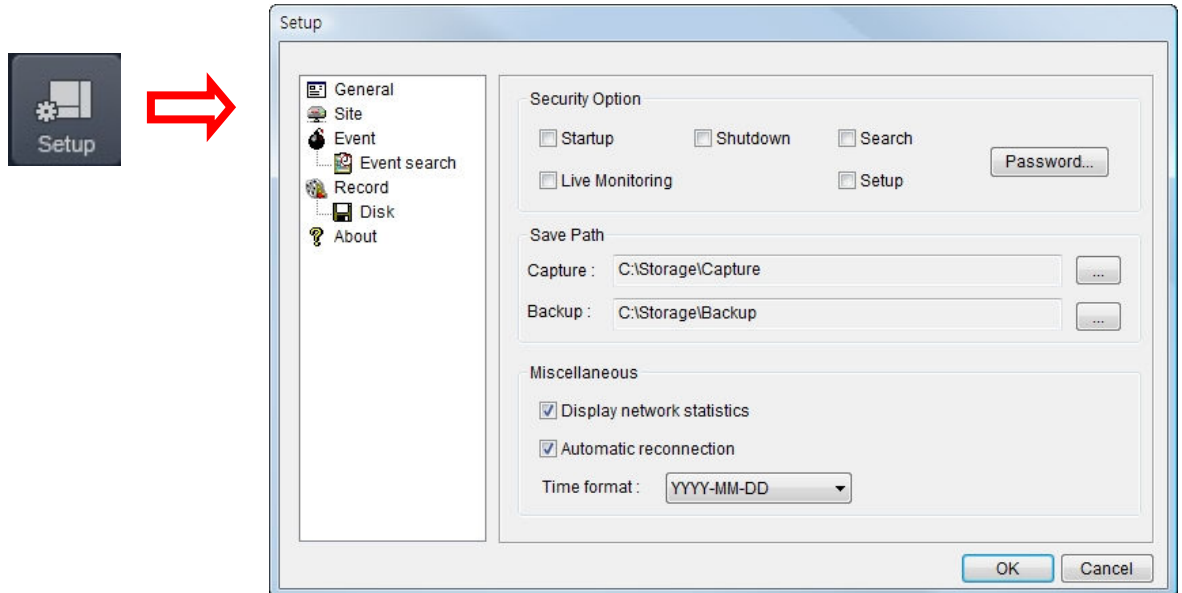

Setting General

Set the Security Option, Save Path, and Miscellaneous.

- **Security Option:** Set a password for security options. When you access any of the selected functions, you will need to enter the password.
- **Save Path:** Specify the location to record for backup and still image capture.
- **Automatic reconnection:** If a user selects this function, the client S/W will automatically try to connect to the previously connected IP address if the network connection is lost.
- **Display network statistics:** If a user selects this function, the client S/W will display network status, Bit rate and Frame rate.
- **Time Format:** Change the mode the Client software displays the time.

Setting Site

The remote DVRs can be added, modified, and removed.

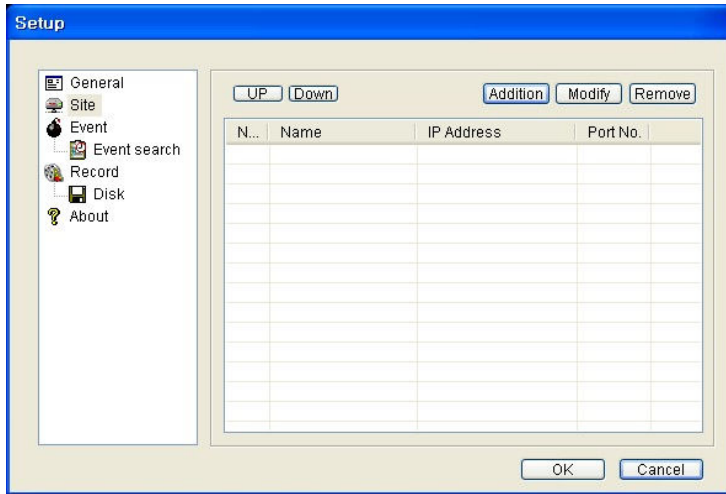

Setting Event

Set the record path and the size of local disk space for the log files.

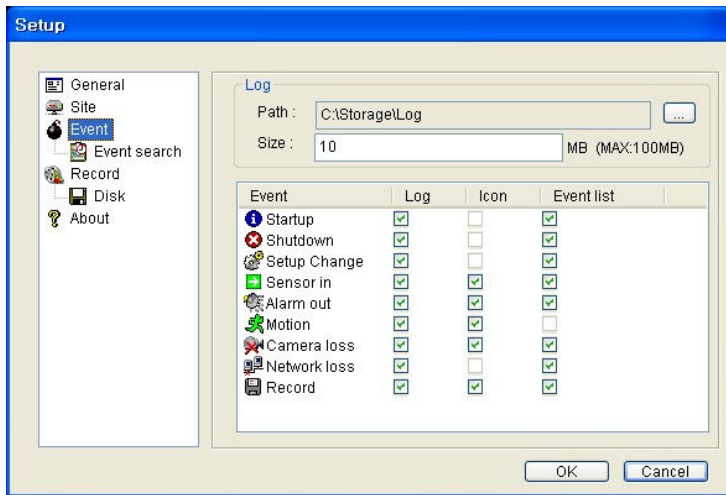

- LOG – Select to save event log into 'log file'.
- ICON – Select to display the event on live video.
- EVENT LIST – Select to show the event in the 'Event List' window of live mode.

Search and check the recorded log data.

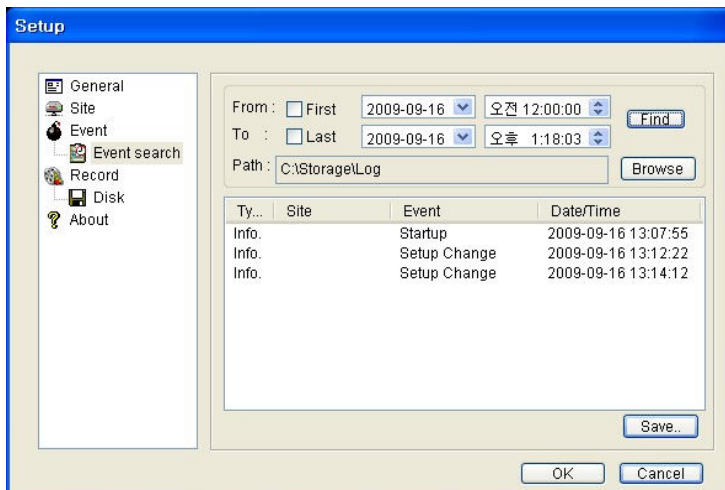

Setting Record

Set the recording conditions and select channels to record.

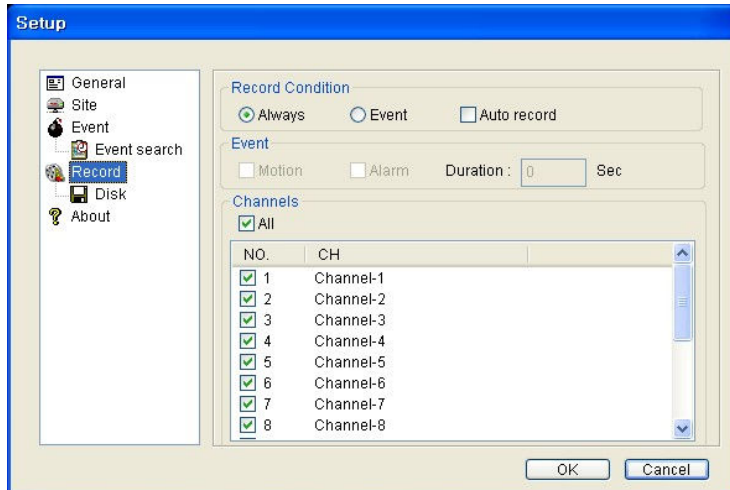

Select the local disk to use and the amount of disk space you want to allow the program to use for recording.

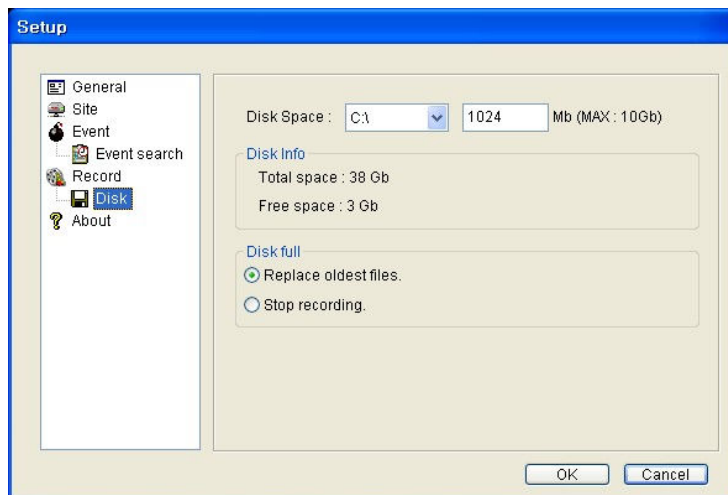

9. Network access using the UMS Multi software

9-1. Installing the program

1. Insert the provided CD in the CD drive and double-click "UMSMultiClient (XXXX).exe"

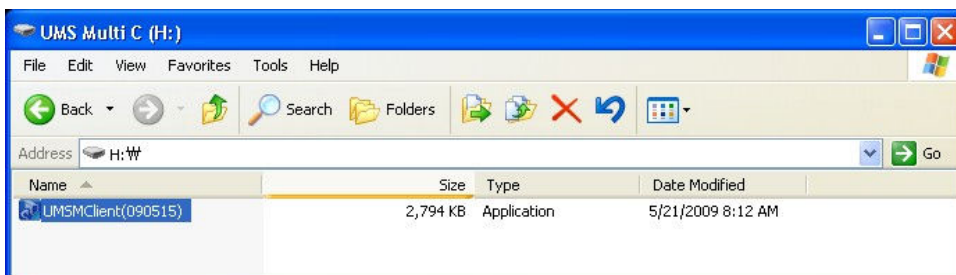

2. Select a destination folder and click “Next”.

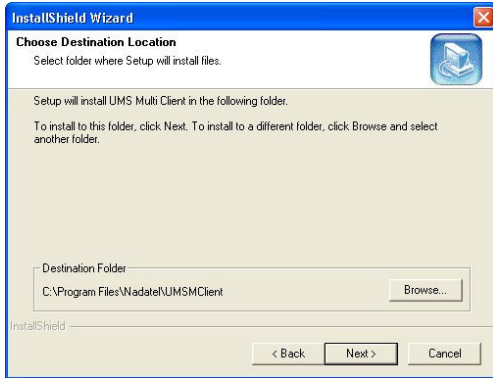

3. Select the program folder and click “Next”.

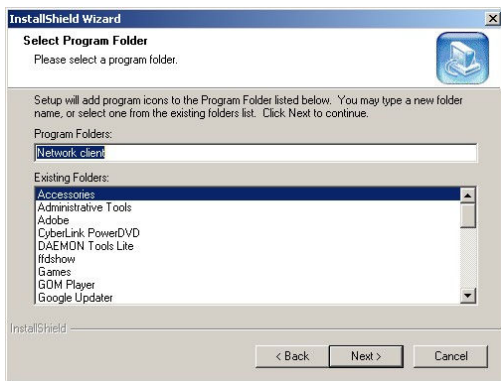

4. The setup status screen is displayed.

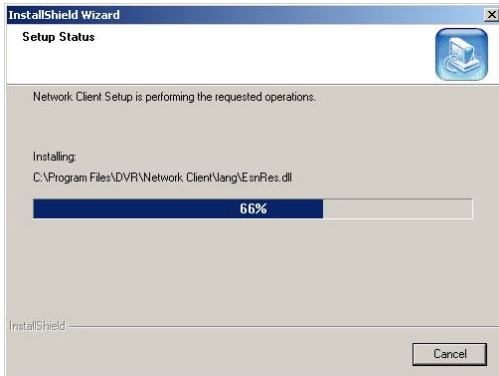

5. After the installation is completed, “**UMS Multi Client**” icon displays on the desktop screen.



9-2. Live Window











When installation is completed, double click the “**UMS Multi Client**” icon on your desktop to start the















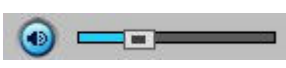

program.

9-2-1. Main user interface



9-2-2. Control buttons

Button	Description
 LOCAL PLAYBACK	Click this icon to run a playback window to search and play videos that are recorded in local PC.
 REMOTE PLAYBACK	Click this icon to run a playback window to search and play videos that are recorded in remote DVR.
 SITE MANAGEMENT	<ul style="list-style-type: none">  THUMBNAIL REFRESH: Click this icon to refresh and renew thumbnail image of every connected site.  SITE ADDITION: Click this icon to open 'Site Addition' window.  SITE DELETE: Click this icon to delete site from the index window, after disconnect a site.  SITE MODIFY: Select the site from the index window and click this icon to open 'Site Modify' window.
 CONNECT	Click this icon to connect the selected site/sites.
 DISCONNECT	Click this icon to disconnect the selected site/sites.
 SETUP	Click this icon to setup configuration of UMS MULTI CLIENT.

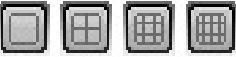
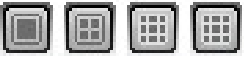
 CAPTURE	Click this icon to capture a still image
 EVENT LIST	
 PAUSE	Click this icon to play/pause live video.
 ALARM ON	
 RECORD ON	Enable or disable recording of live video to local disk which has set in setup menu.
 AUDIO	Use the volume control bar to set the audio level.
 MIC	Use the micro phone volume control bar to set the micro phone level.
	<p>User can control PAN/TILT & ZOOM/FOCUS.</p> <p>   PAN left /right   TILT up/down </p> <p>   ZOOM in/out   FOCUS in/out </p> <p>  Preset </p>
 CHANNEL SPLIT	To select the numbers of display channel/channels (Single, quad, 9 channels, and 16 channels) of highlighted site.
 DVR SITE SPLIT	To select the numbers of DVR/DVRs (1 DVR, 4 DVRs, 9 DVRs, 16 DVRs) on main display screen.

9-3. Search and Playback Window

9-3-1. Main user interface

You can access to search window by clicking the search icon (Local Playback / Remote Playback) on the upper left of Live Window. 

If this software ask the password then please make a new password as bellow.

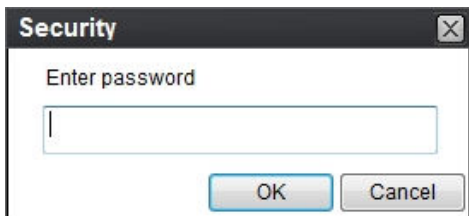

If you found this window then should have to setup the password at the setup menu.

Click this button  and click the password icon as bellow.

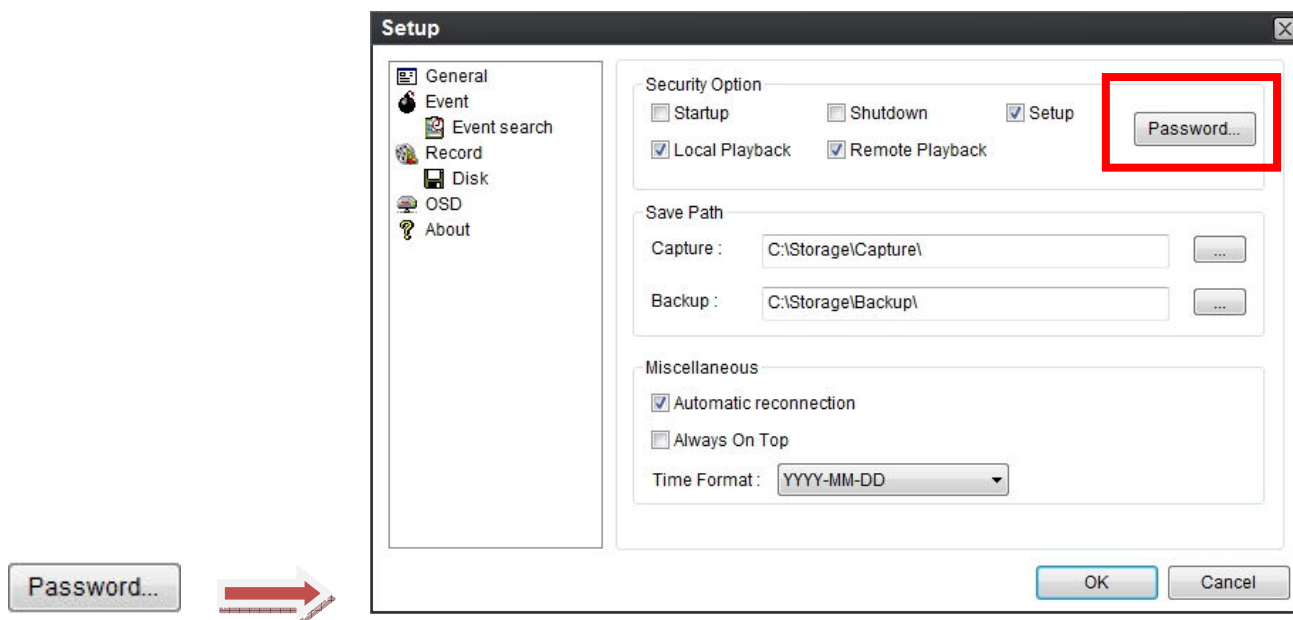





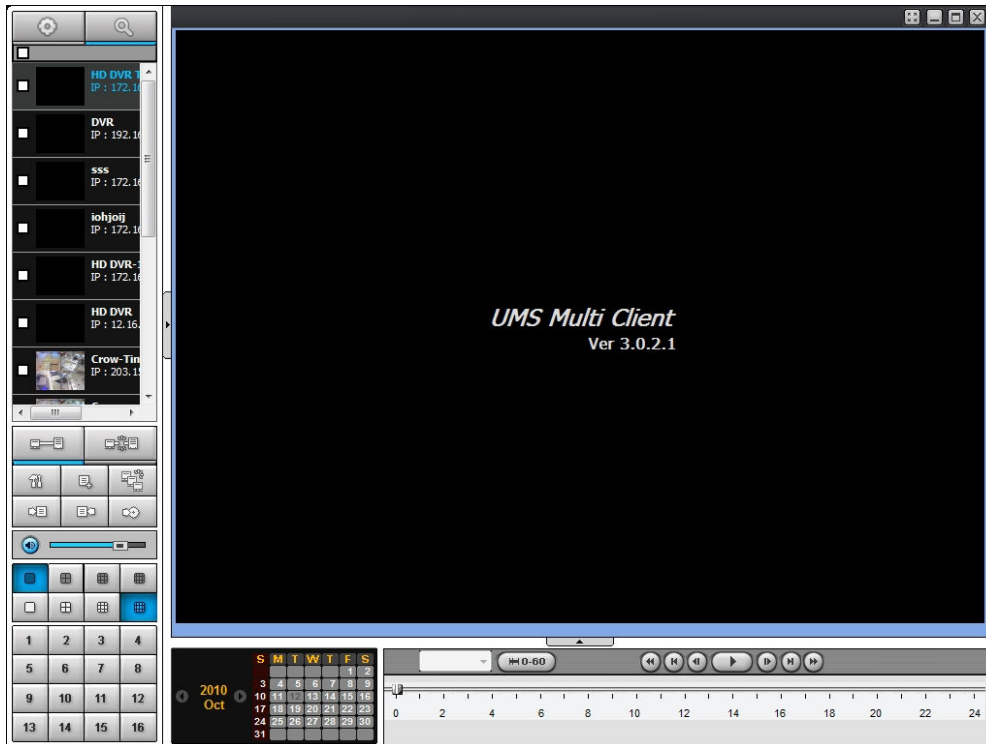











Insert New password and Confirm password.







9-3-2. Main control panel

Button	Description
 LOCAL PLAYBACK	Click this icon to run a playback window to search and play videos that are recorded in local PC.
 REMOTE PLAYBACK	Click this icon to run a playback window to search and play videos that are recorded in remote DVR.
	Directory window shows site/sites that are pre-registered.
 CONNECT	Click this icon to connect the selected site/sites.
 DISCONNECT	Click this icon to disconnect the selected site/sites.

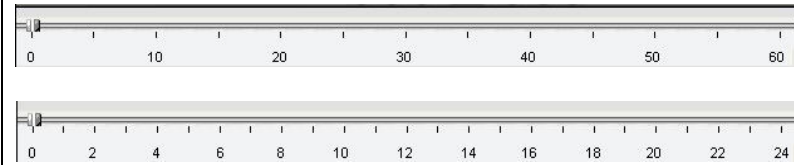
 SETUP	Click this icon to setup configuration of UMS MULTI CLIENT.																
 CAPTURE	Click this icon to capture a still image.																
 EVENT LIST																	
 MARK IN	Click this icon to set the beginning time for backup of the recorded video in AVI format.																
 MARK OUT	Click this icon to set the ending time for backup of the recorded video in AVI format.																
 BACKUP	Click this icon to backup the recorded video in AVI format.																
 AUDIO	Use the volume control bar to set the audio level.																
 DVR SITE SPLIT	To select the numbers of DVR/DVRs (1 DVR, 4 DVRs, 9 DVRs, 16 DVRs) on main display screen.																
 CHANNEL SPLIT	To select the numbers of display channel/channels (Single, quad, 9 channels, and 16 channels) of highlighted site.																
<table border="1" data-bbox="113 1088 416 1330"> <tr><td>1</td><td>2</td><td>3</td><td>4</td></tr> <tr><td>5</td><td>6</td><td>7</td><td>8</td></tr> <tr><td>9</td><td>10</td><td>11</td><td>12</td></tr> <tr><td>13</td><td>14</td><td>15</td><td>16</td></tr> </table>	1	2	3	4	5	6	7	8	9	10	11	12	13	14	15	16	To select the channel to playback.
1	2	3	4														
5	6	7	8														
9	10	11	12														
13	14	15	16														
	The calendar shows dates with recorded video in color.																
	To display the recorded data of selected channel or all channels on a time line scale.																

	<p>To change a time line scale from 24 hours to 60 minutes or vice versa.</p>  <p>The timeline shows recorded data in color on the bar. You can adjust the time line scale and move it to the time you wish to playback. Then click the play icon to display the recorded video.</p>
	<p>Playback buttons.</p>

9-4. Setup of UMS Multi Client

Click the setup icon  to setup the configuration of UMS Multi Client software. The Setup window displays.

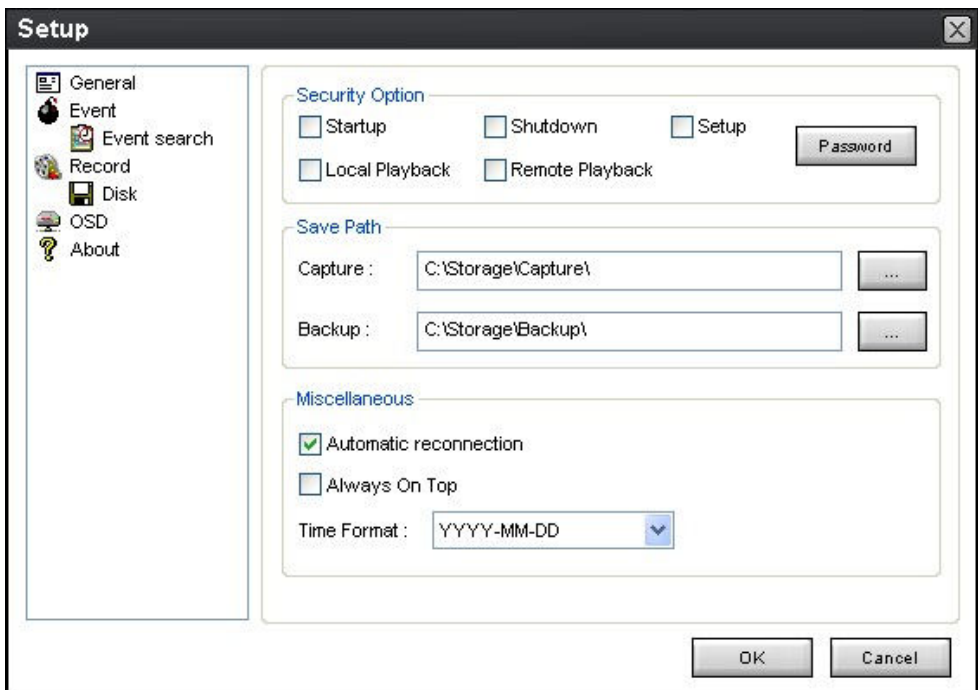

9-4-1. General

9-4-1-1. Security Option: Set a password for security options.

Select security options and set a password.

Then when you access any of selected functions, you need to enter the password.

You can also set the save path for capturing and backup.

9-4-1-2. Save Path: Specify the location to save captured still image for Capture and Backup data.

9-4-1-3. Miscellaneous

Automatic reconnection: If a user selects this function, client S/W will automatically try to connect the finally connected IP address, after the network is disconnected.

Always On Top:

Time Format: Change the way the Client software displays the time.

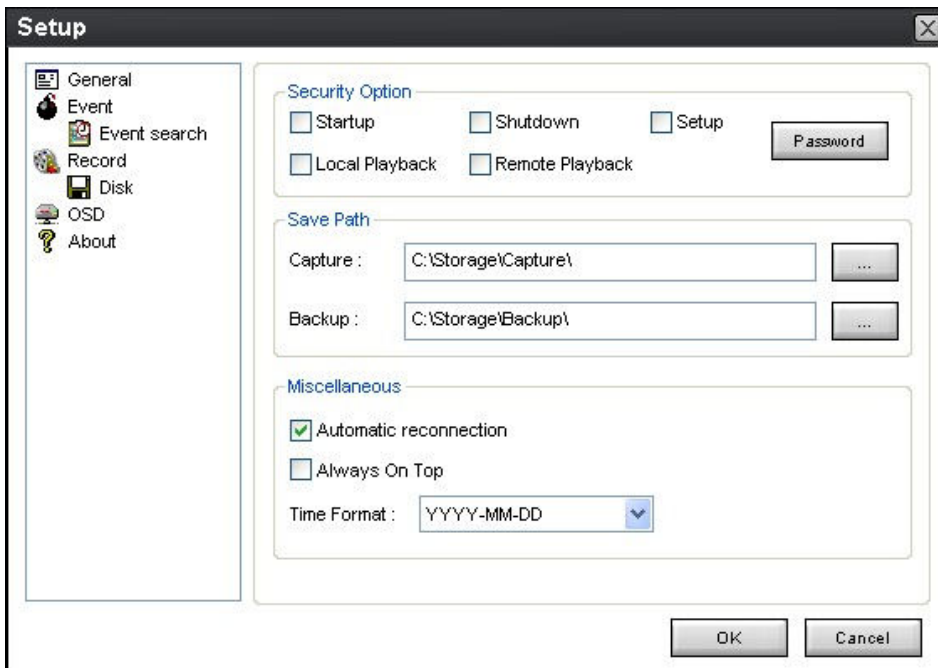

9-4-2. Event

Event log can be archived and searched.

9-4-2-1. Archiving Event Log: Specify the location to save event logs and select event to archive.

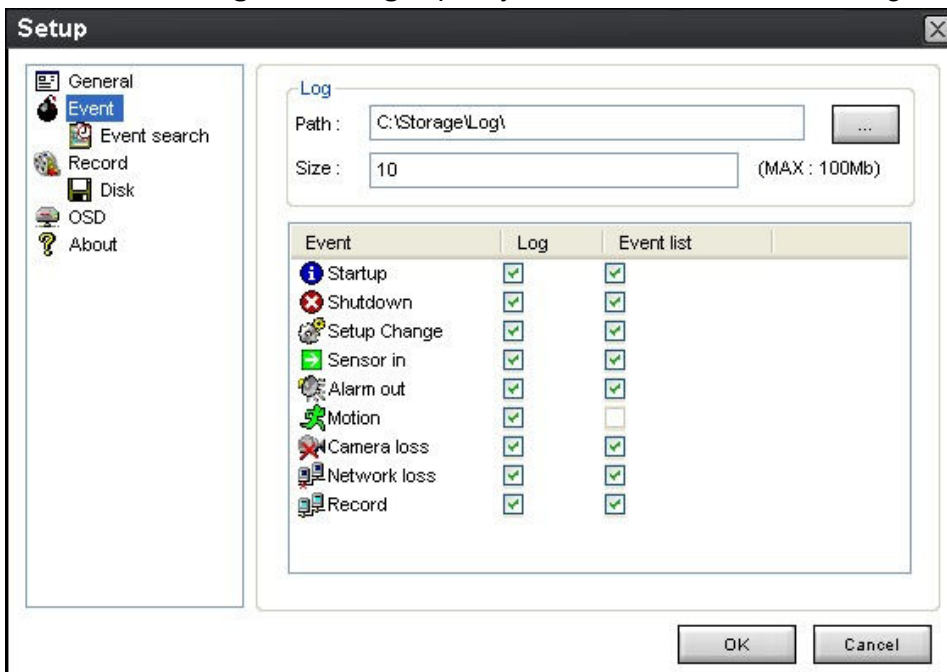

9-4-2-2. Archiving Event Log: Event log can be searched from selected time.

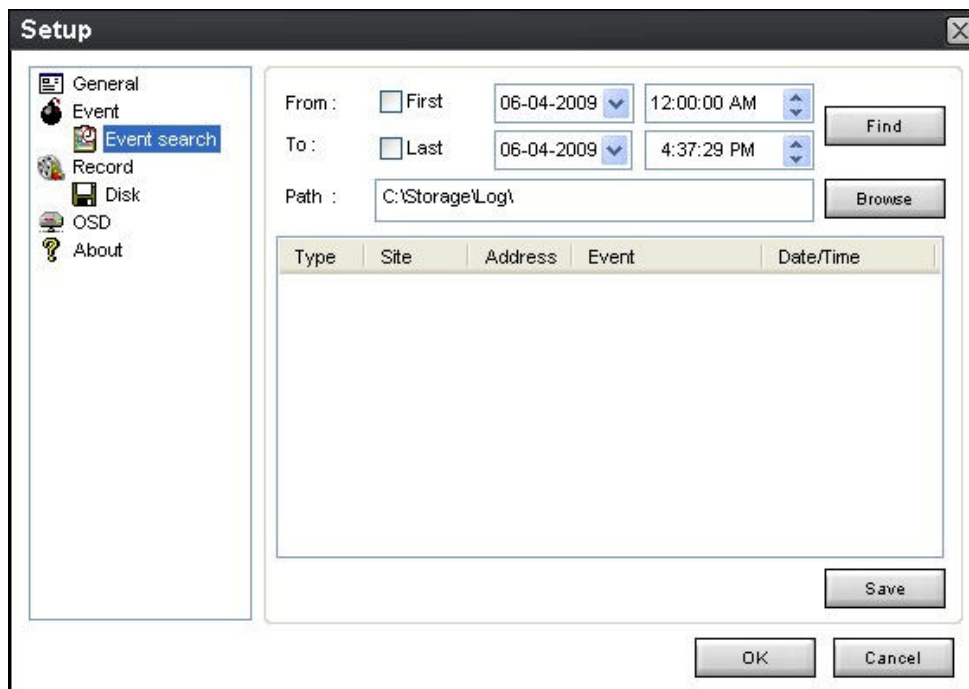

9-4-3. Record

9-4-3-1. Record setup: You can set the recording conditions for Always, Event, or Auto record. And you can also select target DVR/DVRs and channel/channels.

When you set the recording condition to event, you can set event for motion or alarm with duration.

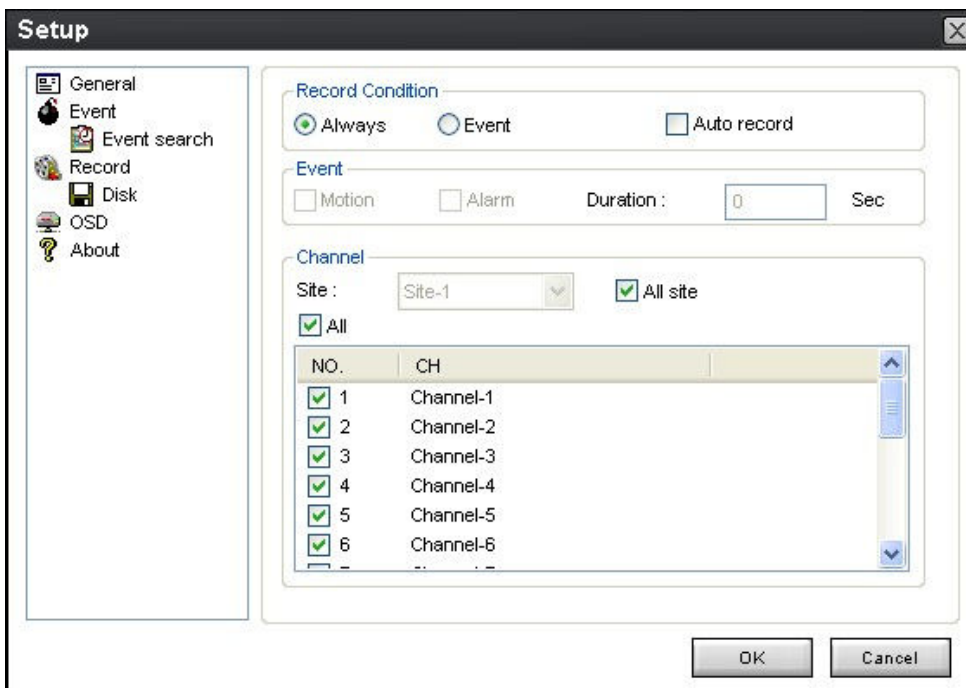

9-4-3-2. Record local storage setup: You can select the local disk to use and the amount of disk space you want to allow the program to use for recording. You can also select the option to overwrite data or stop

recording when the maximum amount of disk space is full.

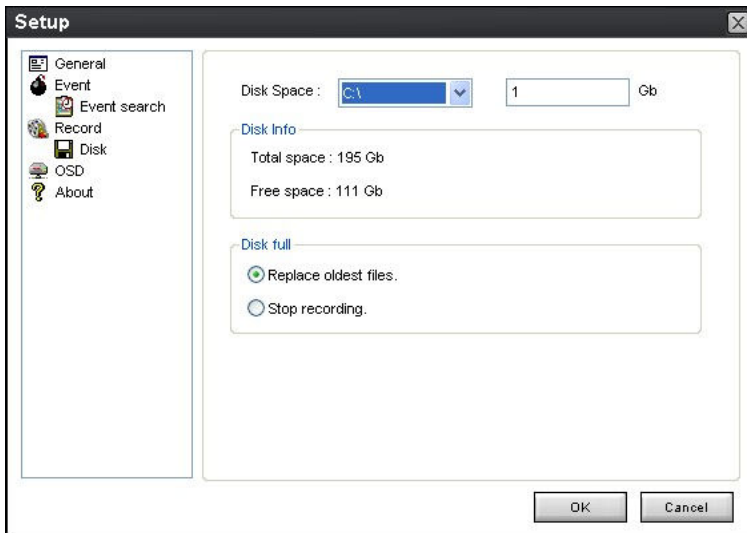

9-4-4. OSD

You can select the OSD to be display

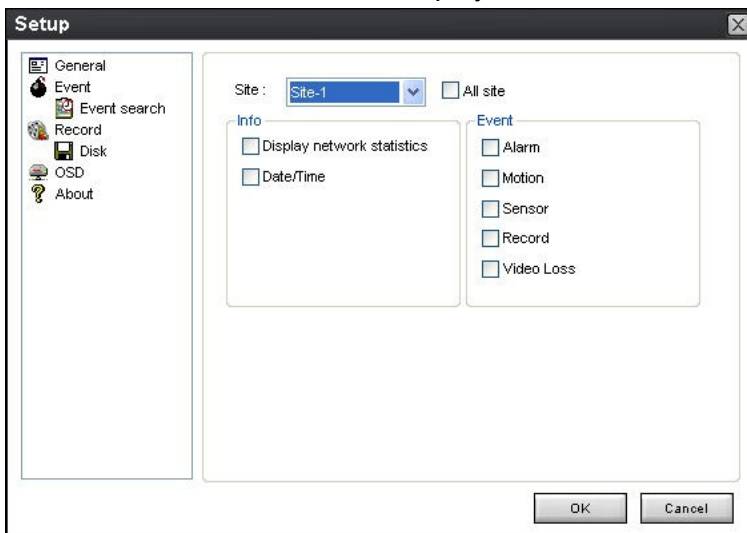

9-4-5. About

“About” provides network client version information.

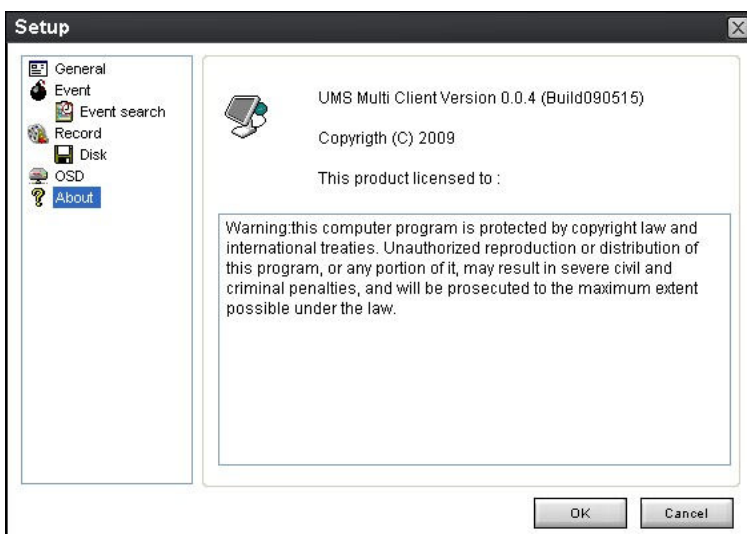

9-5. Remote Setup

The menu settings for the DVR unit can be set from a PC, via network. This function will be supported to the next version.

Put the cursor of the mouse on the channel which is connected to the site and press the right. Then the following window is displayed. Select the **Remote Setup**.

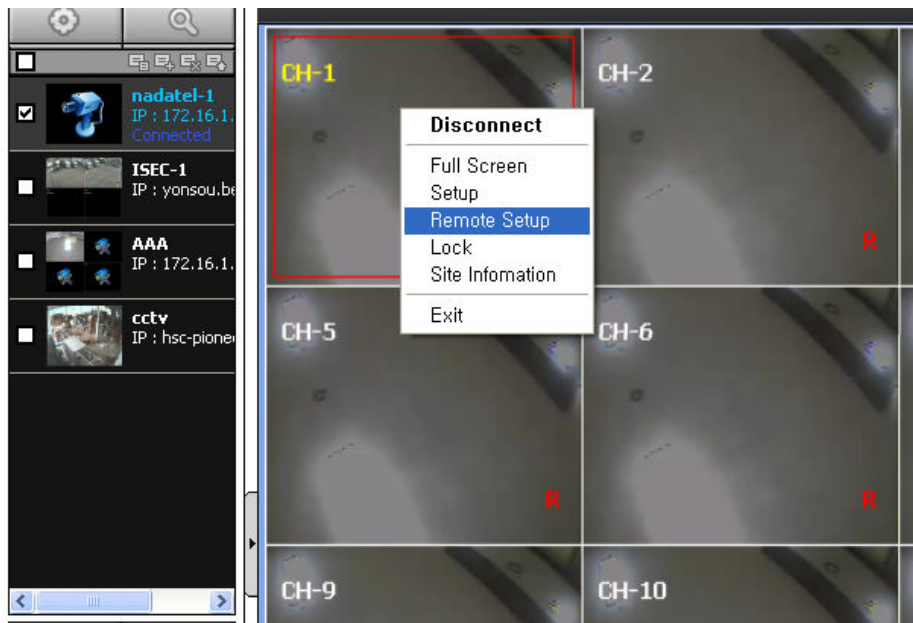

Then the setup window is displayed. The specified menu screen is displayed on the upper left of the screen.

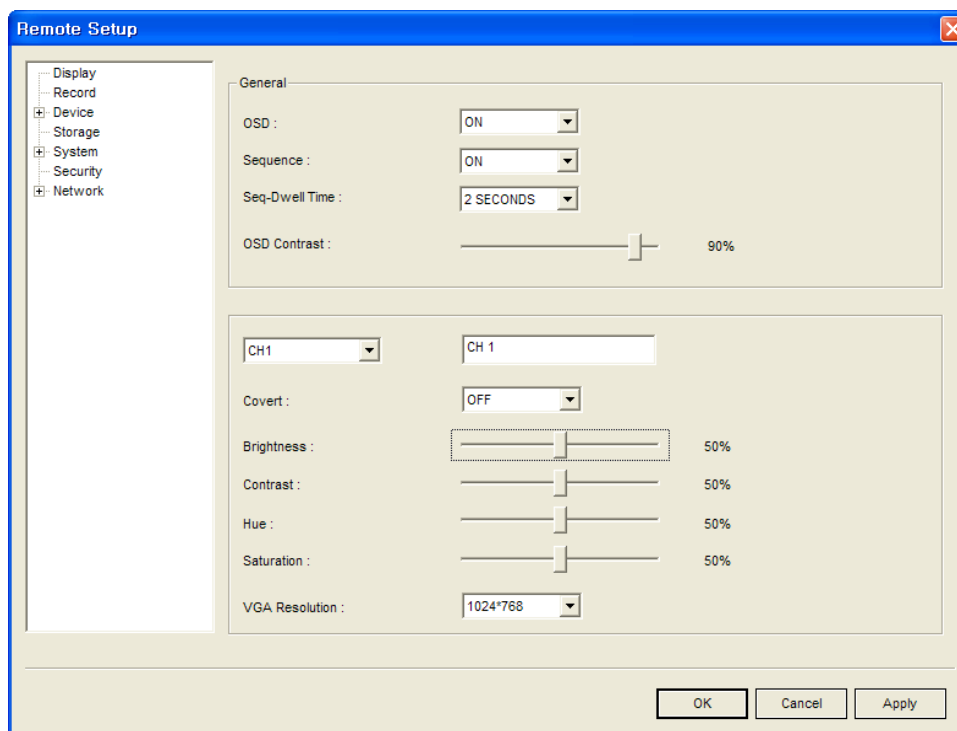

(Memo: Remote setup may not be supported depending on the DVR model or firmware version.)

Setting is basically the same as with the DVR menu setting. Refer to the corresponding pages for details on the setting items.

9-5-1. Setting the Display

Select **Display** to set the live video display conditions

9-5-1-1. General settings

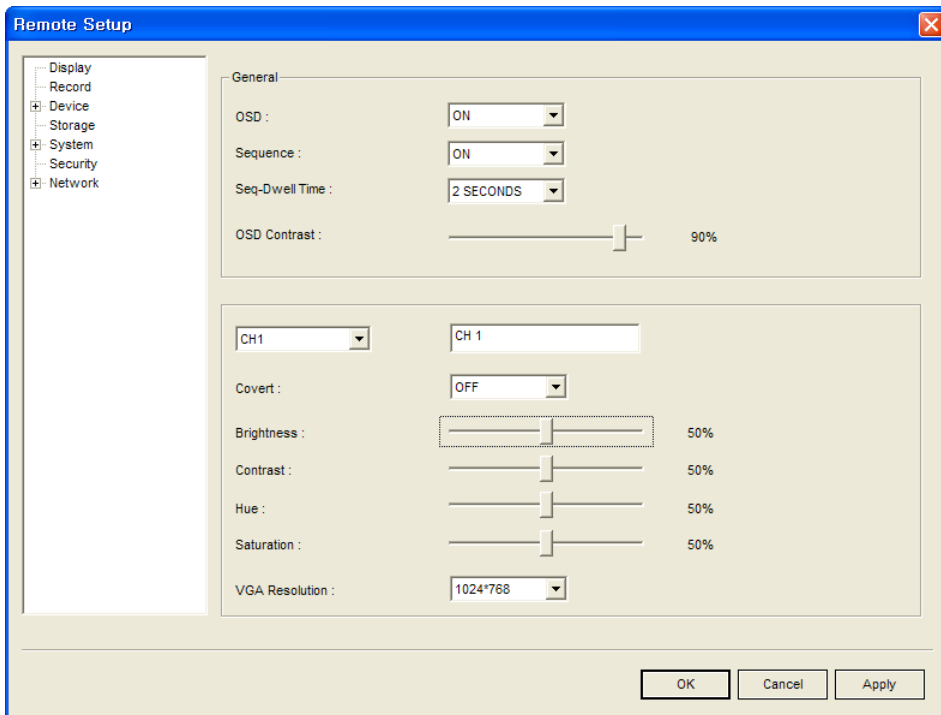

These settings apply to all channels.

OSD: Sets whether to display or not date and time as well as channel number on the screen.

Sequence: Setting for automatically switching the displayed video.

Seq-Dwell Time: Sets the interval for automatically switching the screens.

OSD Contrast: Adjust the character contrast on the screen.

9-5-1-2. Channel-specific settings

These settings apply to the specified channel only.

Channel designation

Covert: Sets whether to display or not video from the channel on the monitor.

Video image adjustment

9-5-2. Record

Select **Record** to set the recording conditions.

9-5-2-1. Common to all channels

Resolution: Sets the resolution for the recordings. The set value applies to all channels.

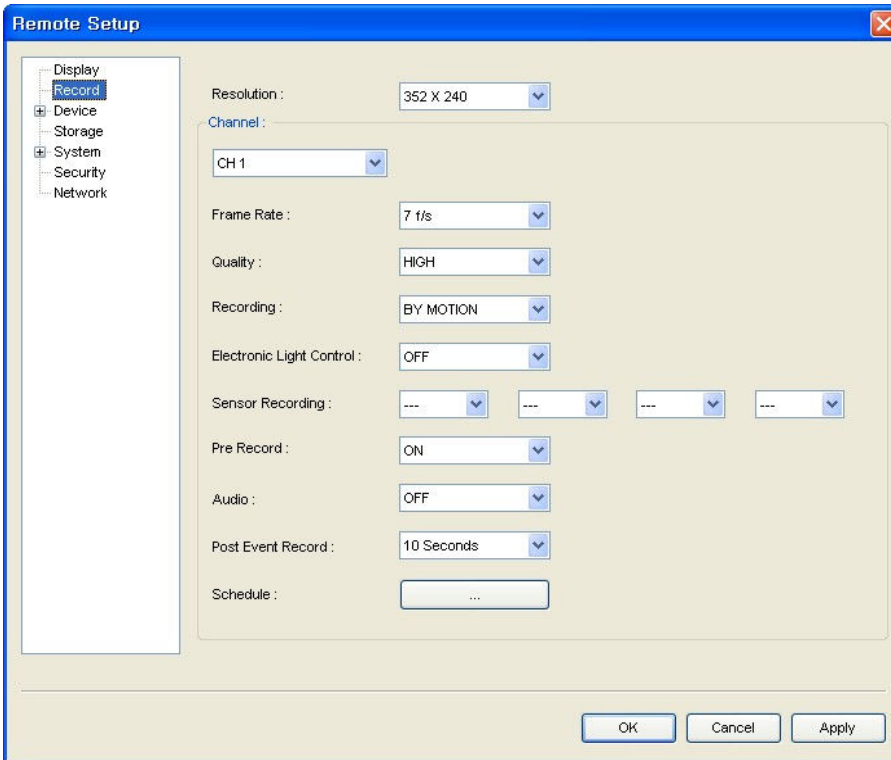

9-5-2-2. Channel-specific settings

These settings apply to the specified channel only.

Channel designation

Frame Rate: Sets the recording rate.

Quality: Sets the image quality in 5 levels.

Recording: Sets the recording mode.

Electronic Light control: Sets whether to perform or not the electronic light control

Sensor Recording: Sensor recording is performed when an external sensor signal is input to the specified external sensor input terminal.

Pre Record: Sets whether to perform or not pre recording.

Audio: Sets whether to perform or not audio recording.

Post Event Record: Sets the duration of the event recording.

Schedule: Sets the schedule for schedule recording.

9-5-3. Device

Select **Device** to set the sensor input/alarm output conditions, PTZ control and spot setting conditions.

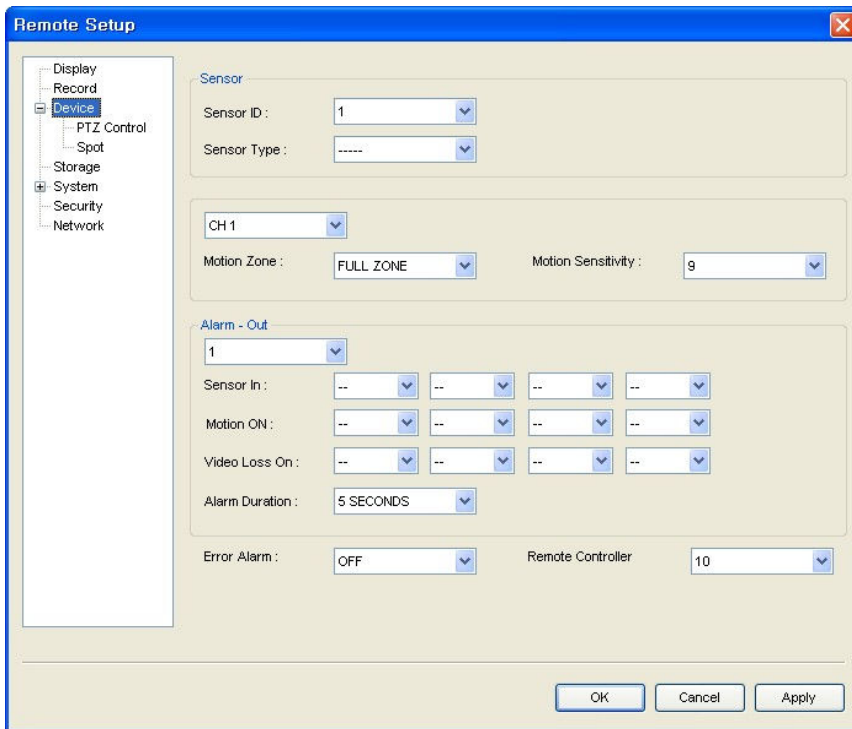

Setting a sensor input terminal: Specify a sensor input terminal number and set the type.

Setting the motion zone/Sensitivity: Select the zone where the motion sensor is active. It is necessary to set a detection frame when PARTIAL ZONE is selected. Select the level of detection sensitivity of the motion sensor. Sensitivity selections: 1~9(High sensitivity level)

Partial Zone: If selecting Partial Zone, a button is displayed to the right. Click the button and click(or drag)a grid cell in the desired detection frame.

Setting an alarm output terminal: Specify an alarm output terminal number (1-4) and set the alarm output conditions.

Alarm out No.: Specifies the alarm output terminal number (1-4)

Sensor In: Outputs an alarm signal when the specified external sensor input terminal receives an input.

Motion On: Outputs an alarm signal when the specified video input terminal receives a motion detection signal.

Video Loss On: Outputs an alarm signal when a video loss occurs in the specified video input terminal.

Alarm Duration: Sets the duration of the alarm output signal

Error Alarm: Sets whether to output or not an alarm signal when the error condition occurs.

(Options are OFF, ALL, HDD ERROR and VIDEO LOSS.)

Remote controller: Sets an ID number on the supplied remote control for its identification.

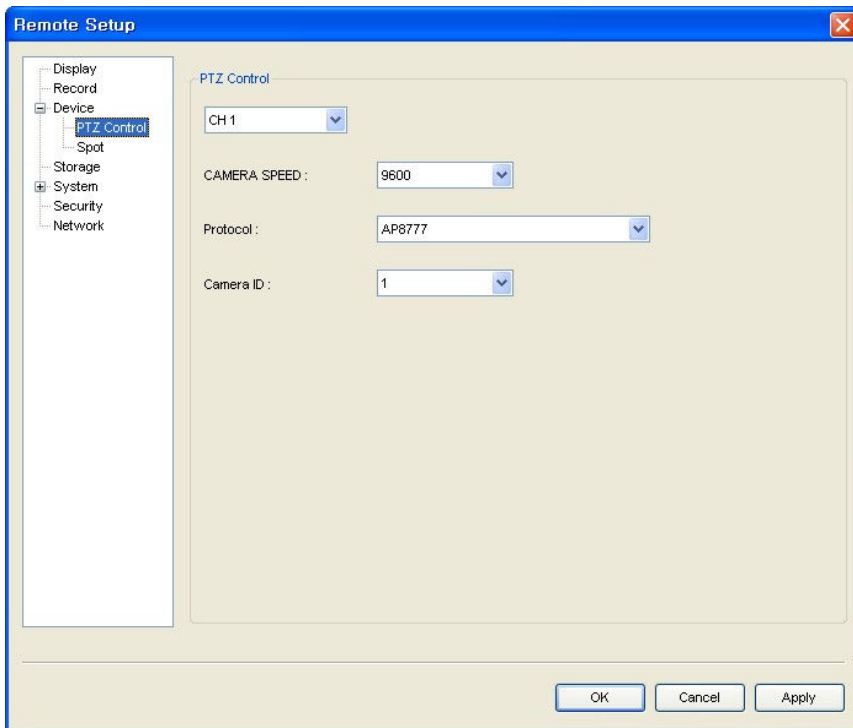

Setting the PTZ Control: Sets the communication environment for remotely operating PTZ dome cameras connected to RS485 terminals.

Camera channel designation

Camera speed: Sets the communication speed. The set value applies to all channels.

Protocol: Sets the protocol type for the specified channel. When connecting multiple cameras, set the same protocol for all.

Camera ID: Sets the camera ID.

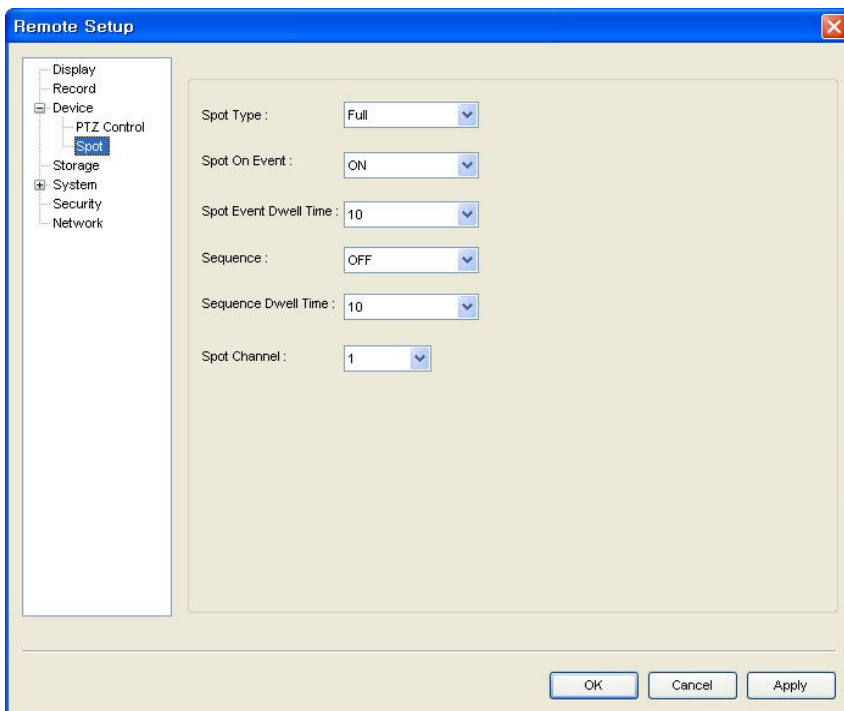

Setting the SPOT: Sets the output conditions of the spot video terminal.

Spot Type: Sets the output screen layout of the spot terminal.

Spot On Event: Sets whether to output or not the video of a sensor recording to spot while it is being recorded.

Spot Event Dwell Time: Sets the output duration of the sensor recording video.

Sequence: Sets whether to automatically switch or not the video output to spot terminal.

Sequence Dwell Time: Sets the video switching interval if Sequence is set to ON.

Spot Channel: Sets the channel that outputs video to the spot terminal.

9-5-4. Storage

Select **Storage** to configure continued recording settings by overwriting the hard disk and the storage period for the recording data.

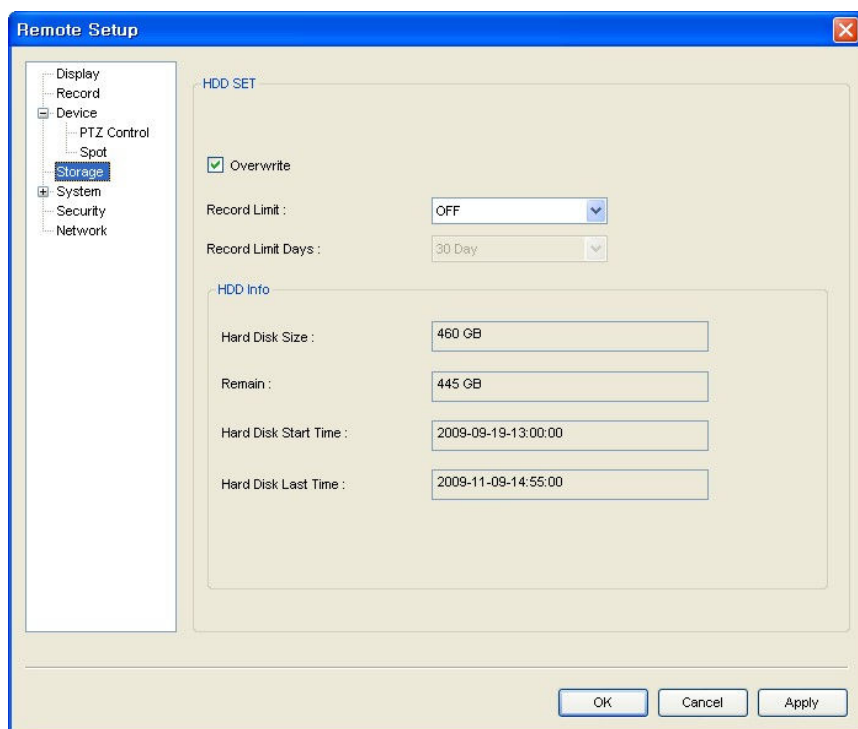

Overwrite: To continue recording by overwriting when the hard disk becomes full, check the checkbox.

Record Limit: Sets whether to limit or not the recording data storage period.

Record Limit Days: Sets a recording data storage period.

9-5-5. System

Select **System** to set system and time settings.

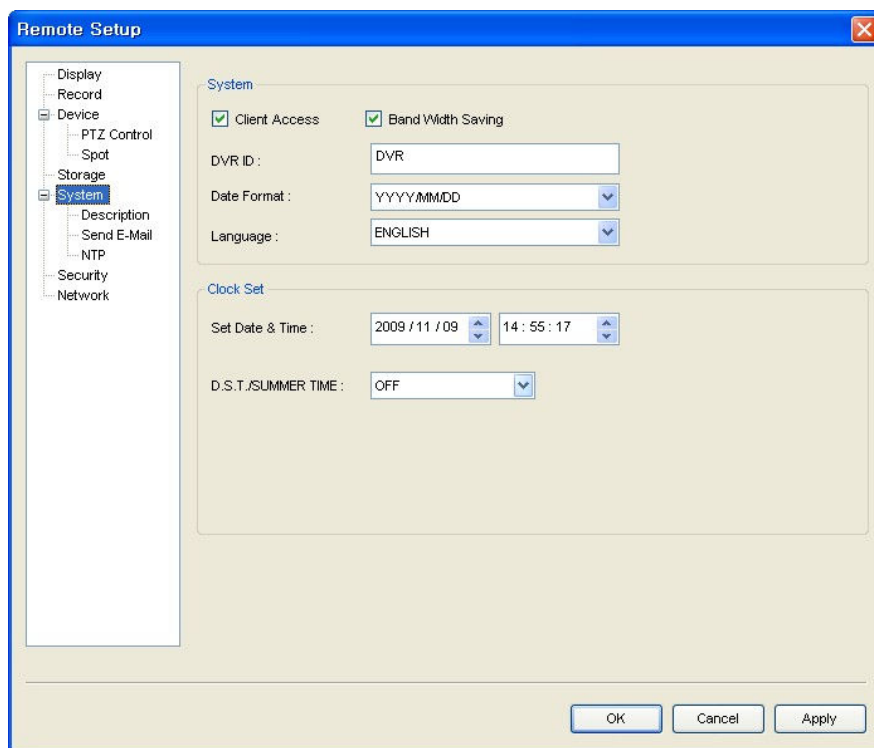

Setting the System

Client Access: To give permission to operate from an external PC by checking the checkbox.

Bandwidth Saving: Sets if the network bandwidth is not large enough when monitoring live videos by checking the checkbox. Live videos advance frame by frame (At the rate of 1 frame per second)

DVR ID: Sets individual designation to DVRs.

Date Format: Sets the date display format.

Language: Sets the display language.

Clock Set

Set Date & Time: Sets the current date and time.

D.S.T./SUMMER TIME: Sets whether daylight saving is applicable or not.

OFF: Daylight saving not applicable.

U.S.A.: USA daylight saving time applicable.

EU: EU daylight saving time applicable. Select the GMT Area. (+00:00 to +05:00)

OTHER: Sets the start and end dates of the daylight saving period for time zones other than USA and EU. (Begin/End)

(Memo: A confirmation dialog is displayed when [Apply] or [ok] is clicked if the date and /or time settings have been changed. The DVR is restarted and the date and time updated when [YES] is clicked on the confirmation dialog.)

Description: To check information on the DVR such as the version information.

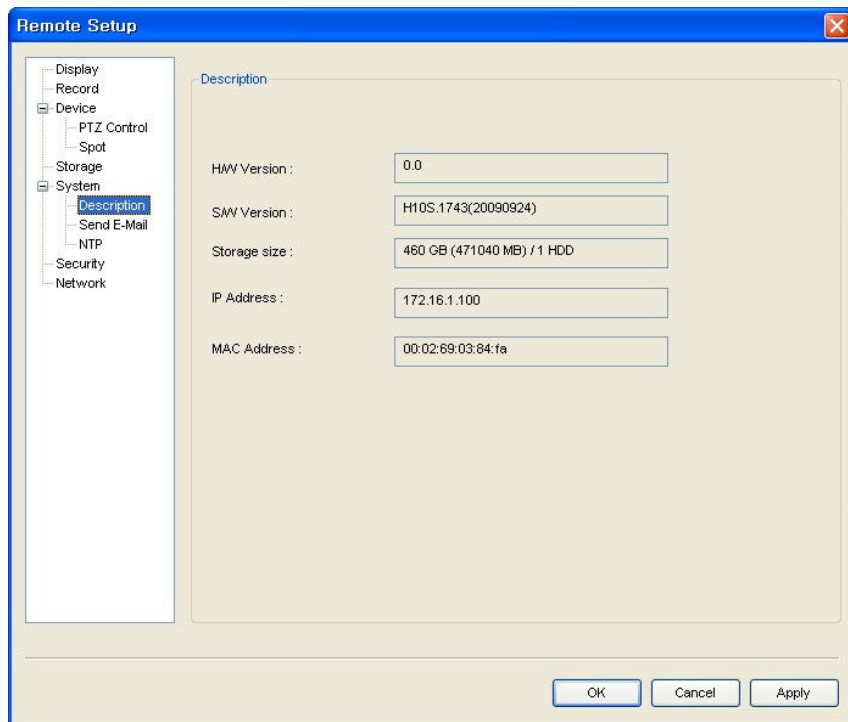

Setting the Send E-Mail:

This setting is used to automatically send a notification e-mail to a specified address when an alarm occurs. (Memo: The DVR will be forcibly restarted if a value on this screen is changed.)

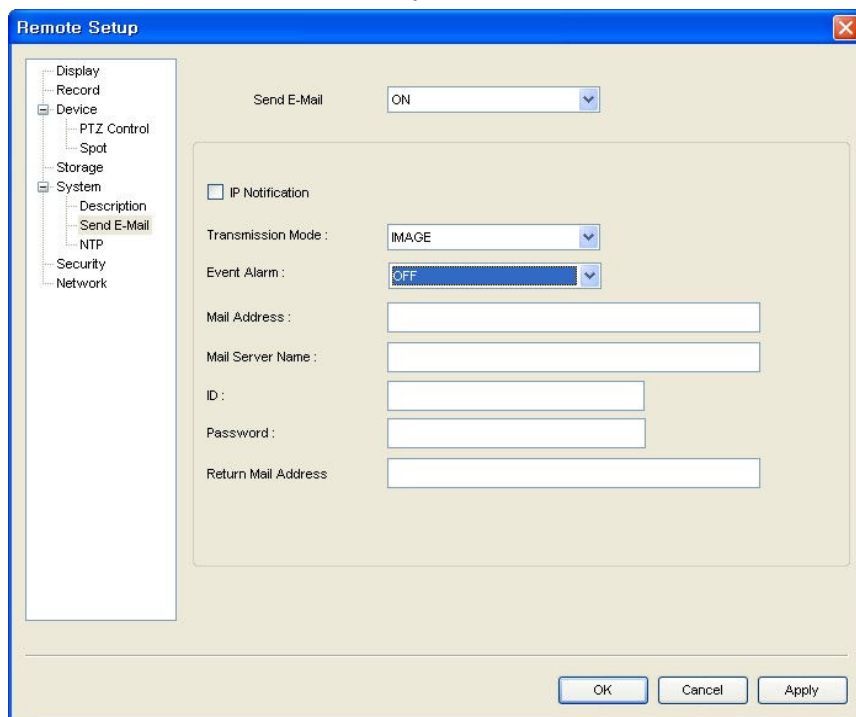

Send E-Mail: Sets whether to enable/disable e-mail sending function.

IP Notification: To send a notification e-mail when the DVR IP address is changed, check the checkbox.

Transmission Mode: Enables sending image of the channel that triggered the alarm when an alarm event is triggered.

Event Alarm: Sets whether to enable/disable sending e-mail reports on the channel that triggered the

alarm when an alarm event is triggered.

Mail Address: Input the destination address.

Mail Server Name: Input the SMTP server name as well as the user ID and password.

Return Mail Address: Set the source e-mail address to be notified to the destination.

Setting the NTP: It allows synchronizing the time using an internet of LAN NTP server.

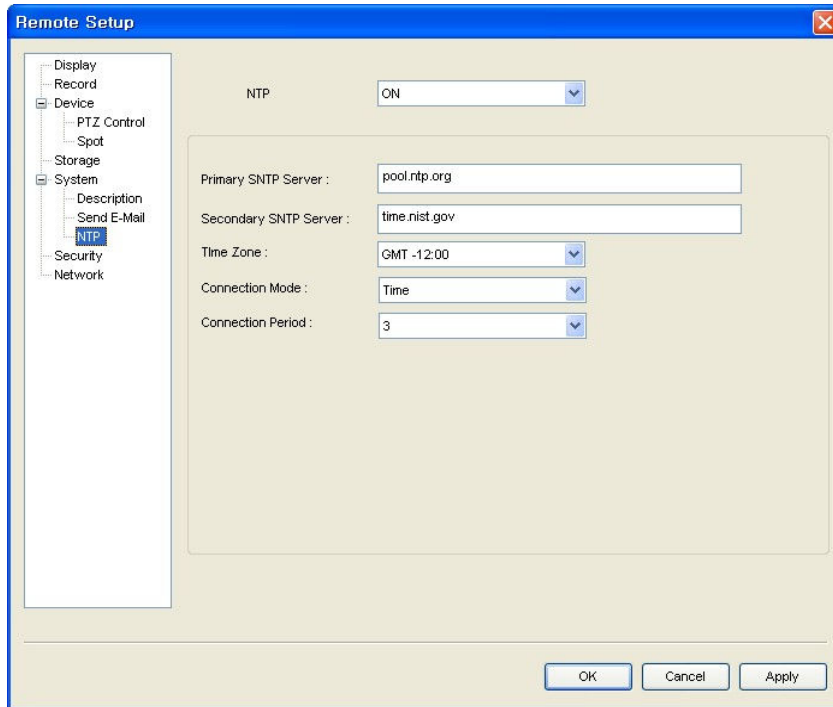

NTP: Sets whether to synchronize the time using NTP server or not.

Primary SNTP Server: Input the NTP primary server address.

Secondary SNTP Server: Input the NTP secondary server address.

Time Zone: Select the time zone.

Connection Mode: Select the connection mode to NTP time server.

Time: Synchronize the time at the time that is set.

Interval: Synchronize the time by hours that is set

Connection Period: Set the connection period.

9-5-6. Security

Select **Security** to set password check for user authentication for the specific functions such as SETUP, PLAYBACK, PTZ control, RECORD OFF, PLAYBACK ON/OFF and NETWORK connection.

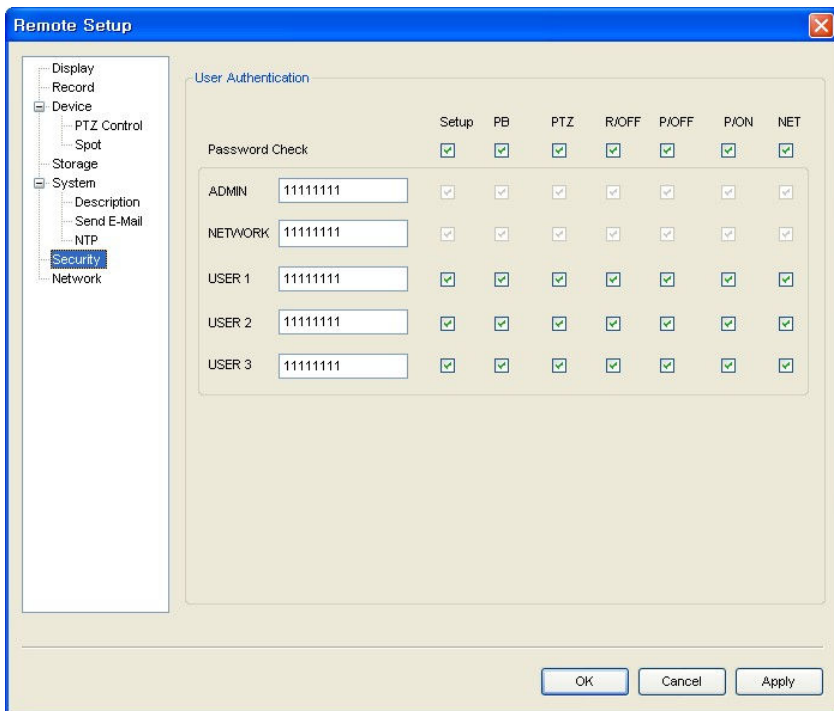

Checking the checkbox: Ask for a password when the given function is selected for all users

9-5-7. Network

Select **Network** to set information about the DVR network.

(Memo: If a value on this screen is changed, the DVR will be restarted.)

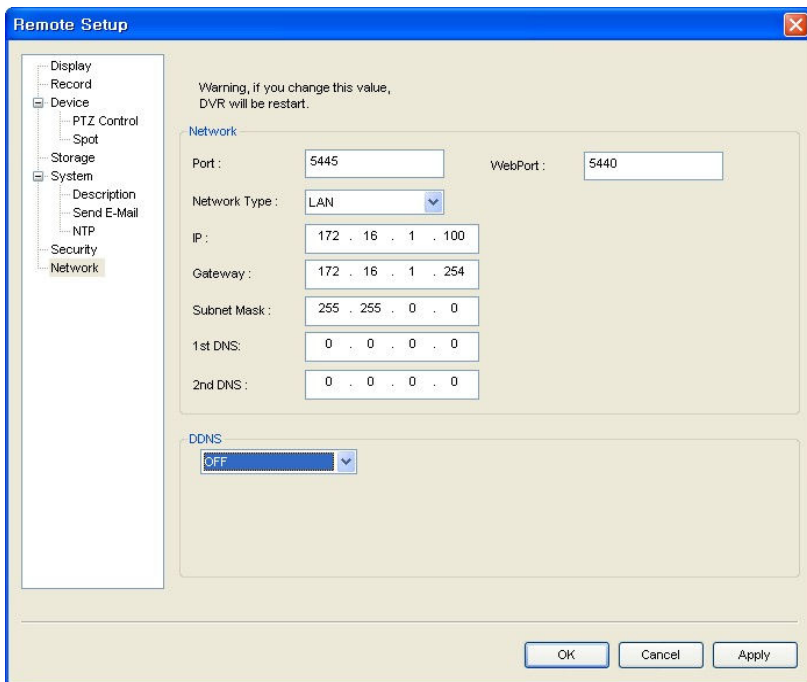

Port: When connecting multiple DVRs to the network, set a unique port number to each DVR.

Web Port: Set a web server port number.

Network Type

LAN: The address setting mode is manual. Input IP, Gateway, Subnet Mask, and DNS server IP.

DHCP: The address setting mode is automatic. Addresses and other information do not need to be set.

ADSL: Input the login ID and Password.

DDNS: Sets whether to use DDNS service or not.

9-5-8.Network – Dual Stream

Select **Dual Stream** to set frame rate and quality for a network streaming.

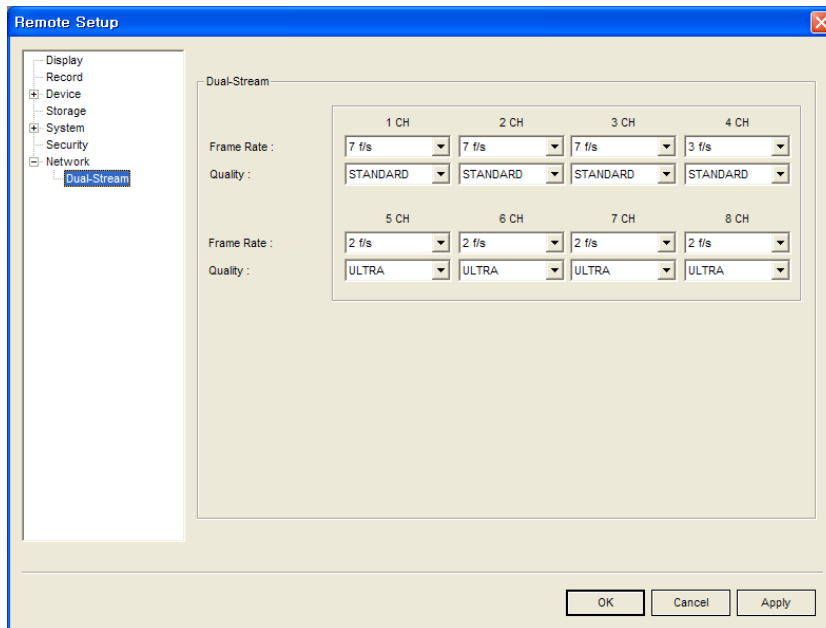

User can set to the following values.

		NTSC	PAL
4ch	Frame Rate	1,2,3,7,10,12 and 15fps	1,2,3,6,8,9 and 12fps
	Quality	Standard, High, Ultra	Standard, High, Ultra
8ch	Frame Rate	1,2,3 and 7fps	1,2,3 and 6fps
	Quality	Standard, High, Ultra	Standard, High, Ultra
16ch	Frame Rate	1 and 2fps	1 and 2fps
	Quality	Standard, High, Ultra	Standard, High, Ultra

9-6. Operation

9-6-1. Addition, Delete, and modify of DVR sites

9-6-1-1. Addition of sites

1. Click  SITE ADDITION button. And then the following window displays.

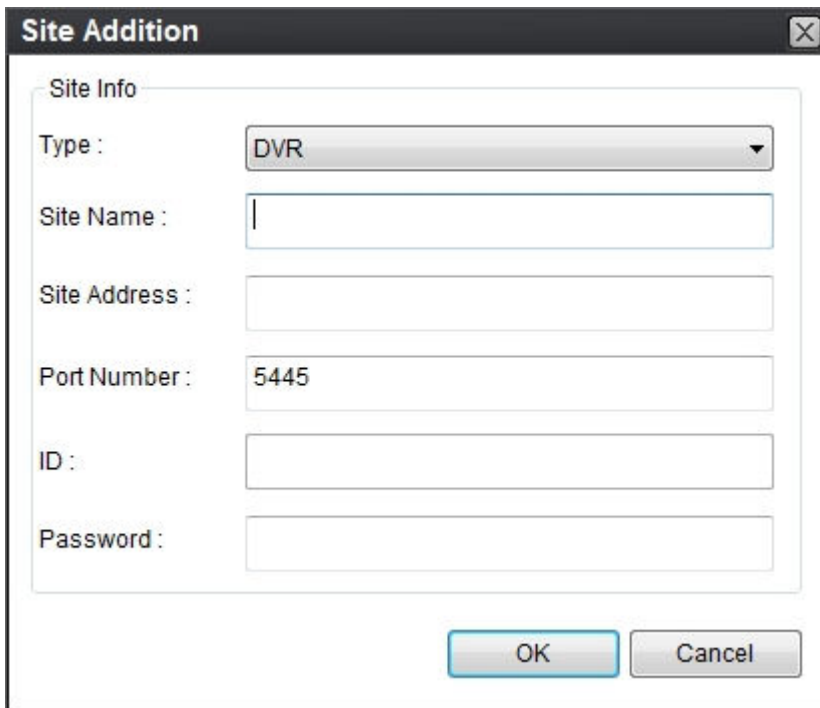

The image shows a 'Site Addition' dialog box with the following fields:

- Type: DVR (selected in a dropdown menu)
- Site Name: (empty text box)
- Site Address: (empty text box)
- Port Number: 5445
- ID: (empty text box)
- Password: (empty text box)

Buttons: OK, Cancel

- Type : Choose the product type
- Site Name: Input a name that properly describes a site.
- IP Address: Input IP address (Public IP address of a router that DVR is connected.) or Domain name that is registered at www.okddns.com (for Korea), www.ddnscenter.com (for USA) or www.bestddns.com (for other area including EU)
- Port No.: Input port number of DVR.
- Password: Input network password of DVR.
- Channels: Select the channels number of DVR.

2. Click OK button. And then the registered site is added on the directory window.



9-6-1-2. Delete of sites

1. Select the site/sites to delete from the directory window.

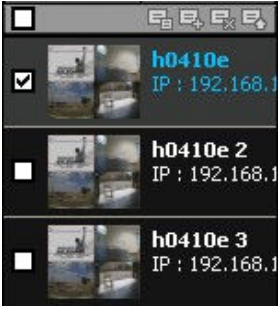

2. Click  SITE DELETE button. And then the selected site/sites is/are deleted.



9-6-1-3. Modify of sites

1. Select the site/sites to modify from the directory window.



2. Click  SITE MODIFY button. And then the following window displays.

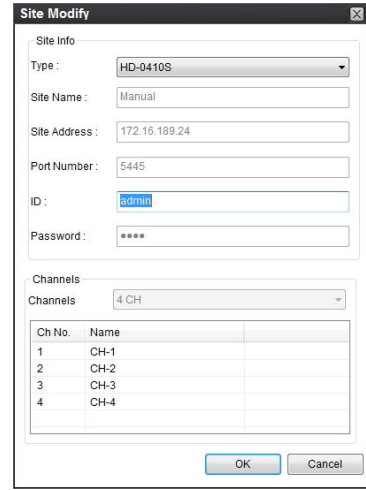
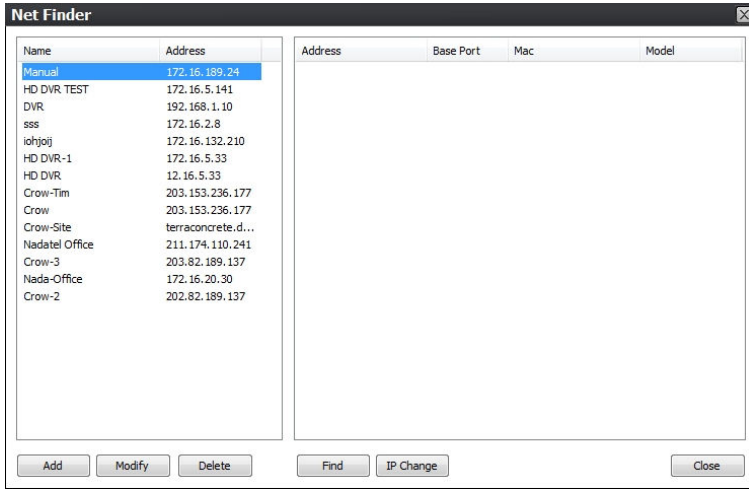

3. Click OK button. And then the modified information is applied.

9-6-2. Connect and Disconnect

9-6-2-1. Connect

1. Select site/sites to connect from the directory window.



2. Click  CONNECT button, and then site/sites displays/display as connected.

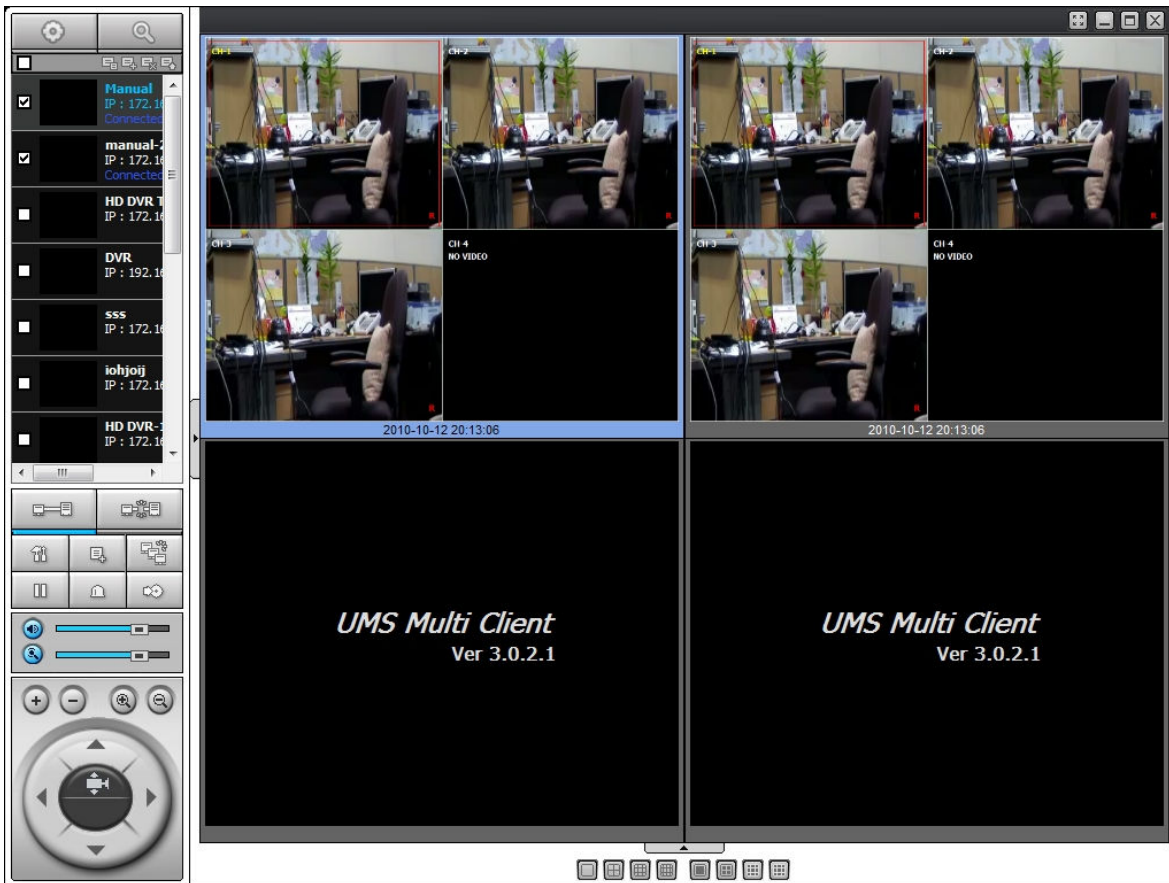

9-6-2-2. Disconnect

1. Select site/sites to disconnect from the directory window.





2. Click  DISCONNECT button, and then selected site/sites disconnected.

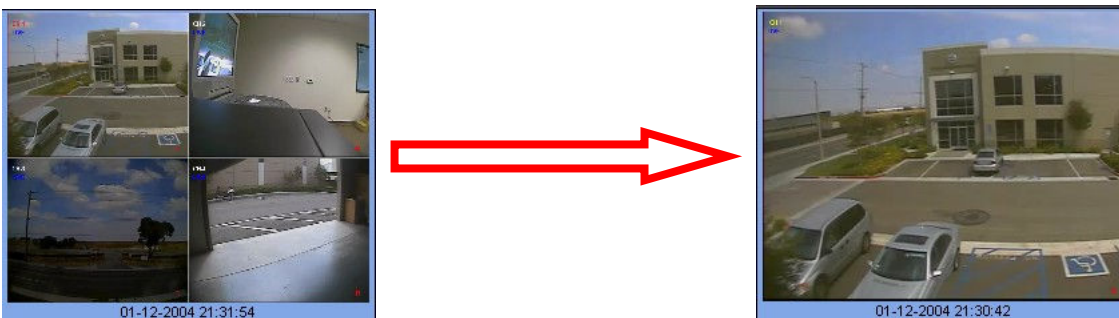

9-6-3. Still-image capture during Live

1. Double-click a channel to capture from the display screen. (Otherwise all channels will be captured.)



2. Click  CAPTURE button. And then a Capture window displays.

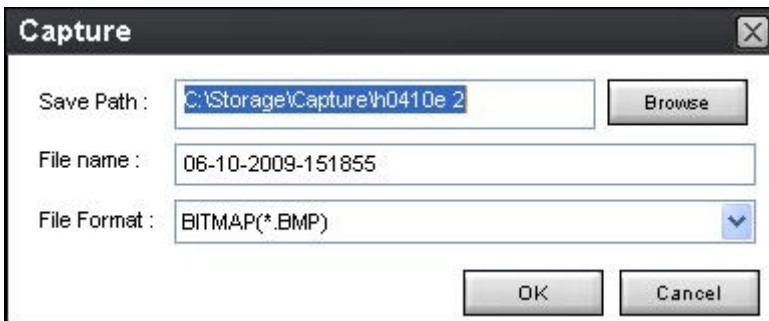

3. Set Save path, File Name, and File Format. And then click OK button.

4. Still image is saved as set in Capture window.

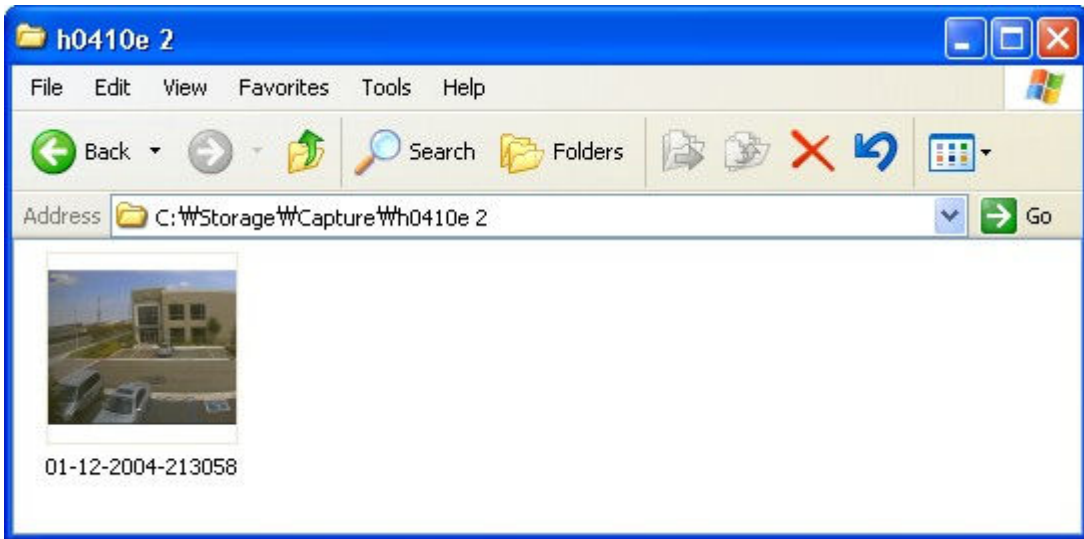

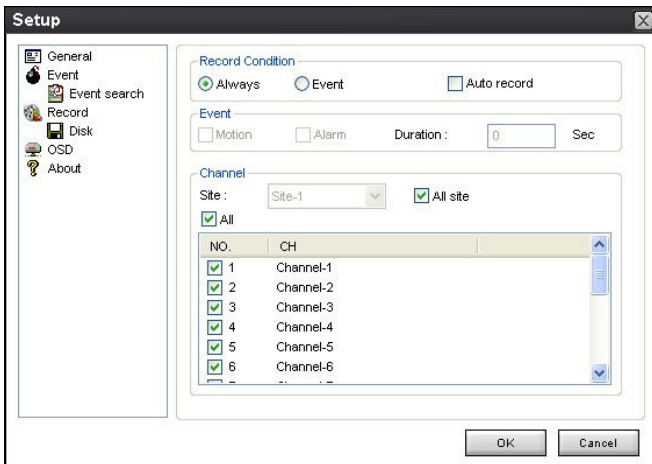

9-6-4. Recording video on local PC during Live

1. Click  SETUP button. And then a setup window display.
2. Select Record and set the values.

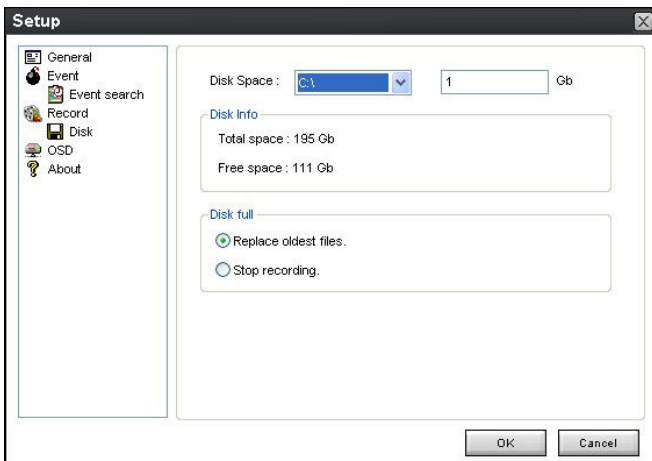

3. Select Disk and set the values.



4. Click  RECORD ON button. And the color of button is changed.

5. Live video data is recorded as set in Record and Disk setup. These video data can be searched and play-backed with Local Playback.

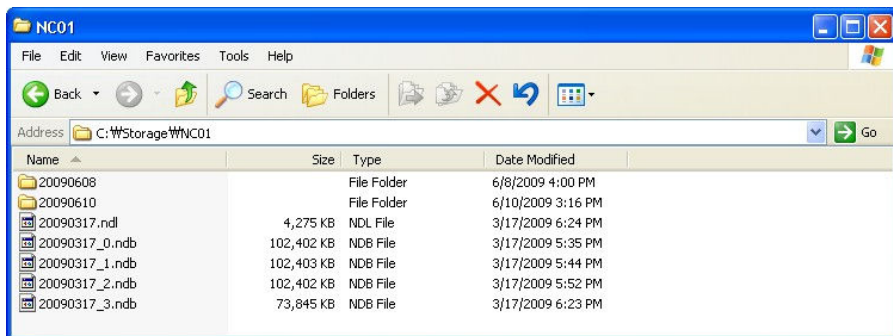

9-6-5. Local Playback and Remote Playback

9-6-5-1. Playback of recorded video on local PC

1. Click  LOCAL PLAYBACK button. And then Playback Window display over Live Window.

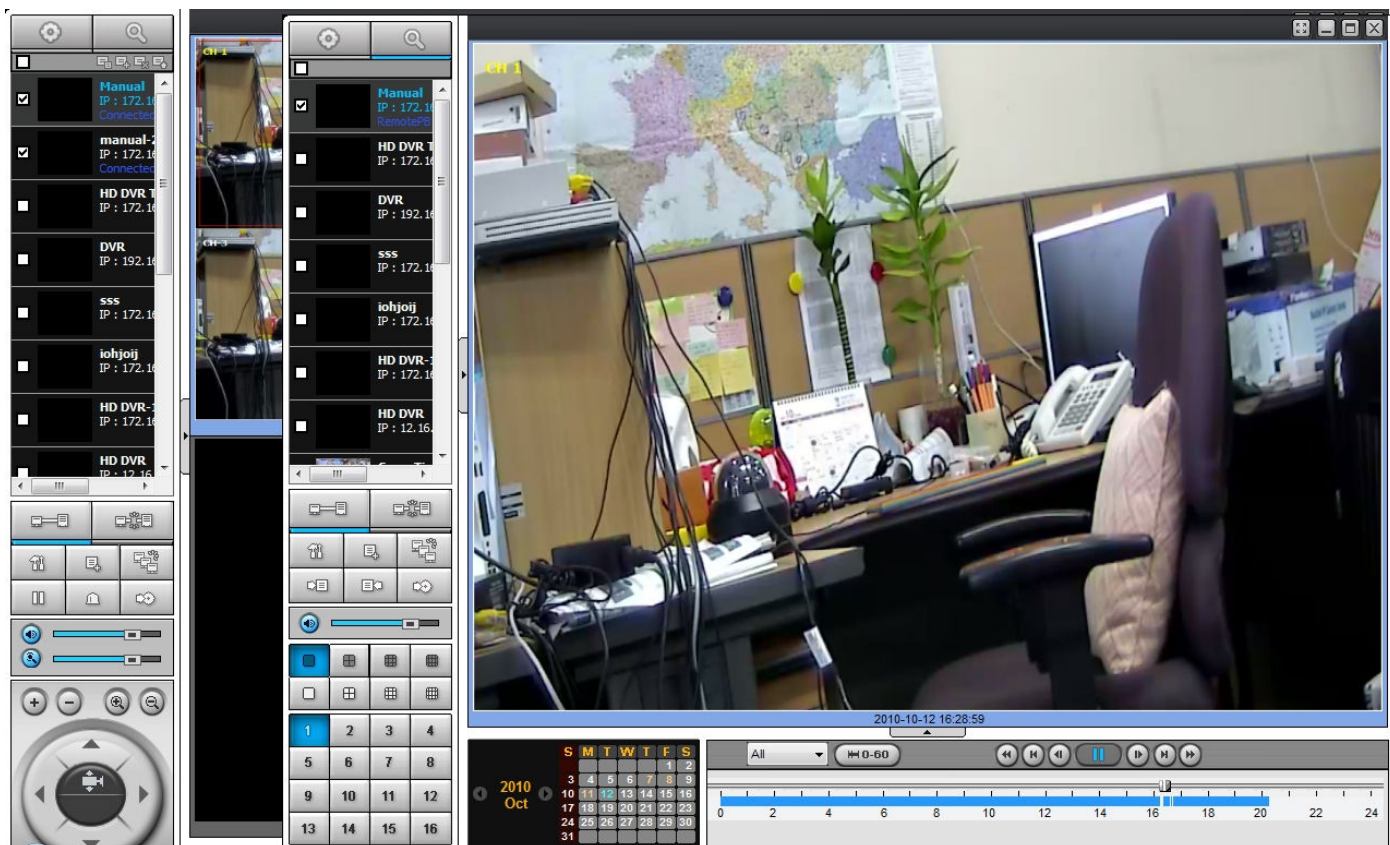

2. Select site/sites to connect from the directory window.

3. Click  CONNECT button. And then Green bar displays on Search calendar and slide window.

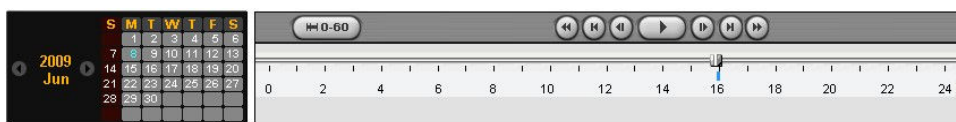

4. Move scroll bar on where there is video data and Play button.

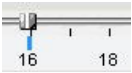

5. Video data that is recorded on local PC will be play-backed.

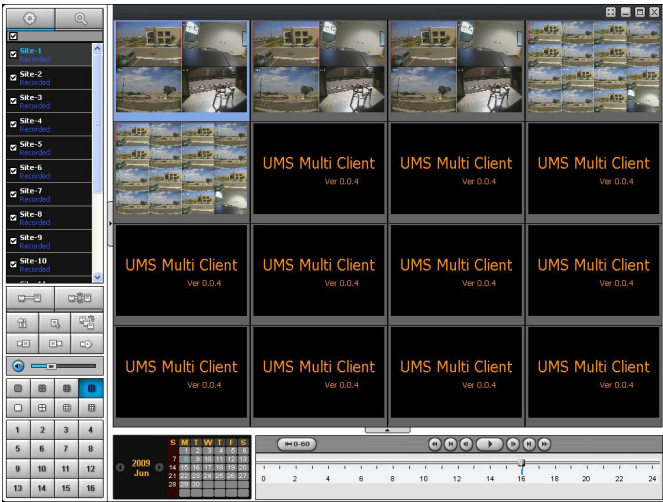

9-6-5-2. Playback of recorded video on remote DVR

1. Click  REMOTE PLAYBACK button. And then Playback Window display over Live Window.

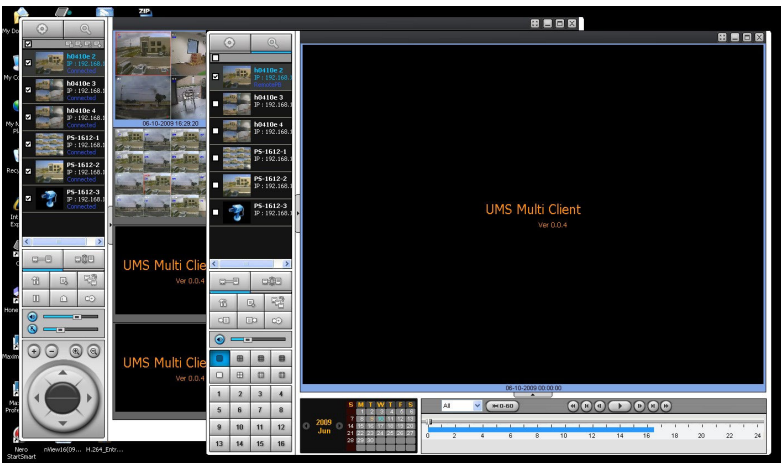

2. Select site to connect from the directory window.

3. Click  CONNECT button. And then Green bar displays on Search calendar and slide window.

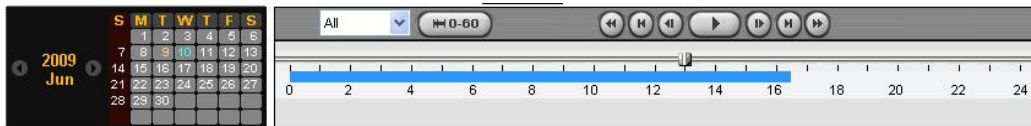

4. Move scroll bar on where there is video data and Play button.

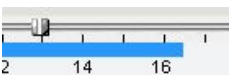

5. Video data that is recorded on a remote DVR is play-backed.



9-6-6. AVI Backup during playback

You can back up the recorded videos in AVI format during playback.

1. Double-click the target channel to backup.
2. Select the beginning time by using the search calendar and slide bar.

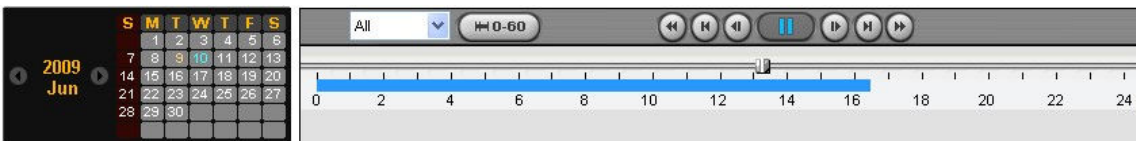

3. Click  MARK IN button, when the scale of the timeline is located on the target time as the beginning time of backup.

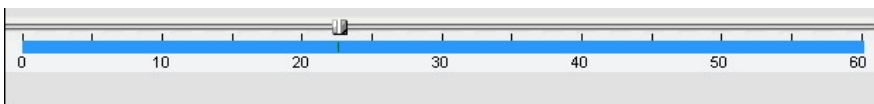

4. Set the ending time on the blue timeline by dragging the scale on the target time as the ending time of backup and clicking  MARK OUT button. Then, color of the timeline between the beginning time and ending time will be changed into dark Green.

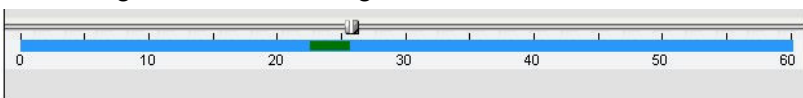

5. Click  BACKUP. And then the window appears as below.

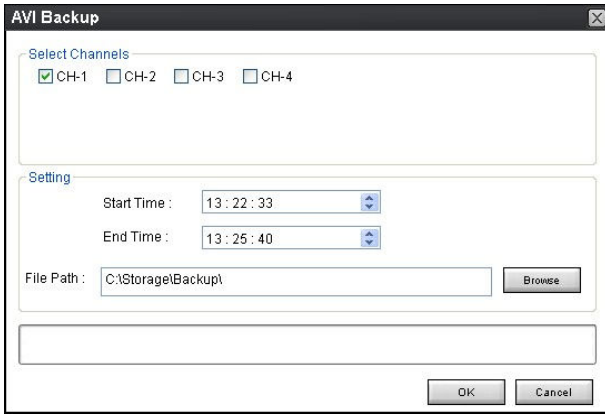

6. You can also set the beginning time and ending time on this window. After selecting a channel for backup, click the OK button. The backup will begin.

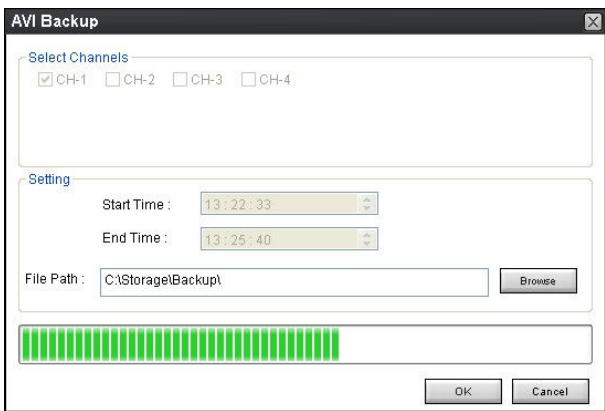

7. AVI video data is recorded as set in AVI Backup window. AVI format video can be played back by Window Media Player™ or other media player that is compatible with AVI format video.



Notice

When PC doesn't have proper H.264 CODEC, the media players cannot playback the AVI format video. Then install CODEC that is provided on the CD.

10. Network – By an web-browser viewer

The DVR provides a live remote monitoring feature by web-browser viewer.

1. Check the IP address of the DVR from SETUP>SYSTEM>DESCRIPTION>IP ADDRESS.
2. Input the IP address or Domain name address that you pre-registered on www.bestddns.com (Use www.ddnscenter.com in US) on the address field and press “Go”.



3. Click this bar. Then the dialog box is displayed.

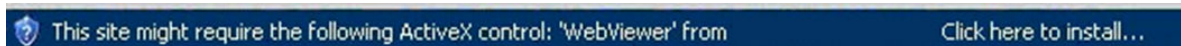

4. Click “Install” to download ActiveX control.



5. Web Browser Viewer is displayed as bellow.



6. Click CONNECT button on the Left upper corner of web-viewer. Then “Connect” dialog is displayed. Enter IP address (or Domain name address that you pre-registered on www.bestddns.com), Port number and Password and click “Connect”

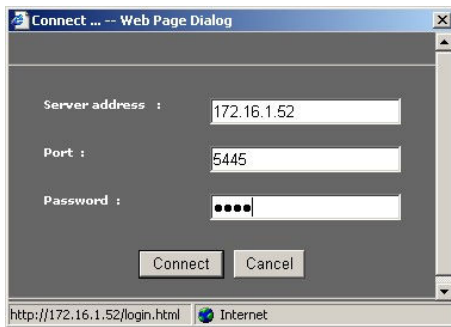

- Server address: Input IP address of the DVR from SETUP>SYSTEM>DESCRIPTION>IP ADDRESS or Domain name address that you pre-registered on www.bestddns.com
- Port: Input Port number (The number sets on SETUP>NETWORK>PORT)
- Password: Input Password (The number sets on SETUP>SYSTEM>NETWORK PASSWORD)

7. Then the cameras connected to the DVR are displayed on the screen.

APPENDIX: How to connect network

A. How to set IP address of the DVR and open TCP port of the router?

The port forwarding is dependent on the brand and model of the router. The port forwarding is required to allow access to the DVR beyond a router.

Connect network cable between DVR and Router or ADSL modem.

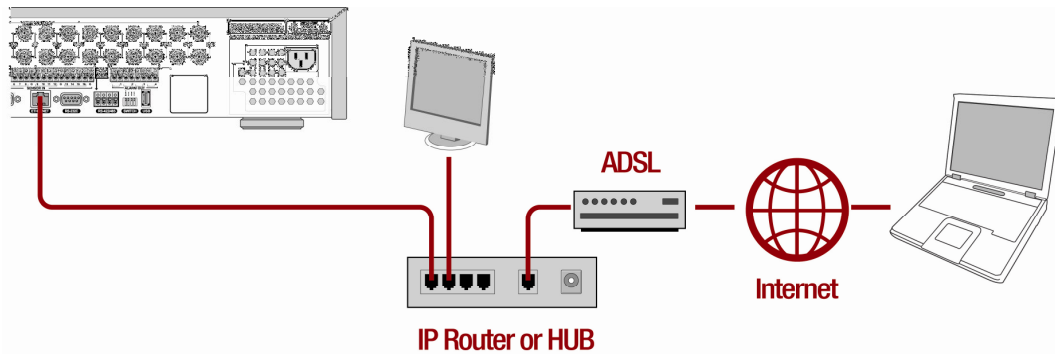

1. Default network setting on DVR are
 - Port: 5445
 - WEB Port : 80
 - Network : DHCP
2. From PC connected in the same Router, find IP address, Gateway, and Subnet mask by IPCONFIG command in command prompt.

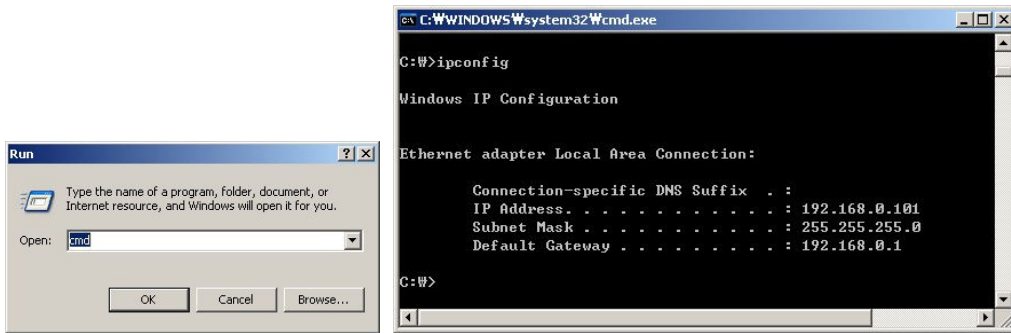

3. But if IP is something else like 192.168.x.xxx., you should change IP address, Subnet, Gateway on the DVR. Go to SETUP>NETWORK>LAN of the DVR and change the IP settings to be like IP: 192.168.XXX.XXX and Gateway: 192.168.XXX.XXX. (Refer to the user's manual of Router.)

Open your web browser. Enter the router IP address in the address bar (The router IP address are different with the brand and model.), click GO.



4. Enter the user name and password (**admin** is default) and press the **OK** button.

User name:  

Password:

Remember my password

5. Select the Port Range Forwarding tab.

Setup | Wireless | Security | **Access Restrictions** | Applications & Gaming

Port Range Forward | DMZ

Port Range						
Application	Start	End	Protocol	IP Address	Enable	
<input type="text"/>	5445	to	5445	Both	192.168.1.1	<input checked="" type="checkbox"/>

6. Enter the each field.

- i. Application: Enter a description of the DVR (Example: store1)
- ii. Start: Enter the first number of the port you need to port forward (Example: 5445)
- iii. End: Enter the last number of the port you need to port forward (Example: 5445)
- iv. Protocol: Select Both.
- v. IP address: Enter the IP address of the DVR on SETUP>NETWORK>LAN>IP ADDRESS.
- vi. Enable: Check the enable box.

7. Select the Save settings button located on the bottom of the window. Then Port forwarding is finished.

Network access beyond a router

In order to access the DVR remotely beyond a router (firewall), the user must open TCP port for command level, live channels and storage channels. User need to open 2ports numbers.

If the DVR port number is set to 5445, open the TCP port 5445 and 5446 on the router.

If this port is not opened properly, user can not access DVR beyond a router.

If dvr supports remote setup function over the network, user need to open additional port 5455 which is the 10th number from the basic port number.

Web viewer and Mobile-phone web viewer Network access beyond Router

In order to access beyond Router (Firewall), user must open 1 TCP port that is set on NETWORK > WEB PORT. If this port is not open properly, user can not access DVR using direct Web viewer or Mobile-phone web viewer. (Example: When NETWORK > WEB PORT is set as 80, 80 TCP port of IP address of DVR must be open.)

You can learn how to port forward many kinds of Routers from the bellow site.

http://www.portforward.com/english/routers/port_forwarding/routerindex.htm

B. How to access DVR from Remote PC?

LAN Connection – Using a switching hub

Connect to the system, using a hub (Switching hub) and an Ethernet cable (10BASE-T/100BASE-TX CAT 5 LAN cable)

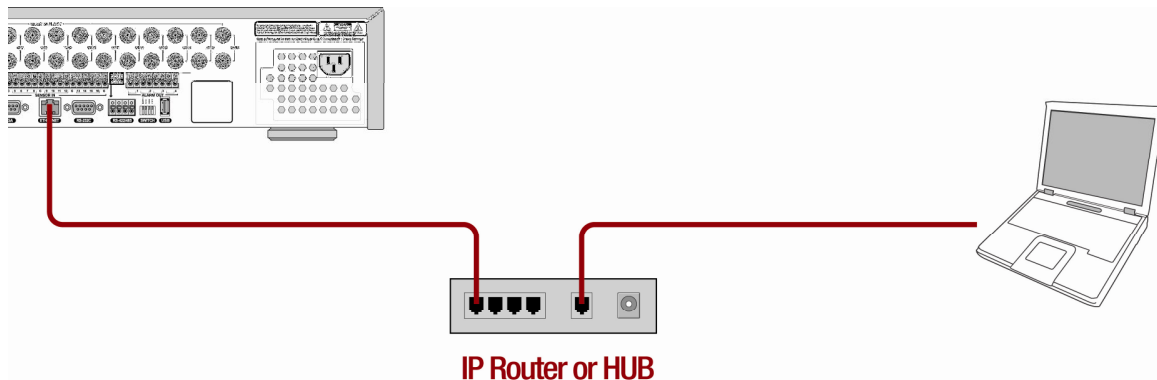

1. Run the pre-install the network client software on the supplied CD. (Refer to Chapter 6. Network access using the Exclusive network viewer)
2. Check the IP address from SETUP>SYSTEM>DESCRIPTION of DVR.
3. Run network client software and click CONNECT button.

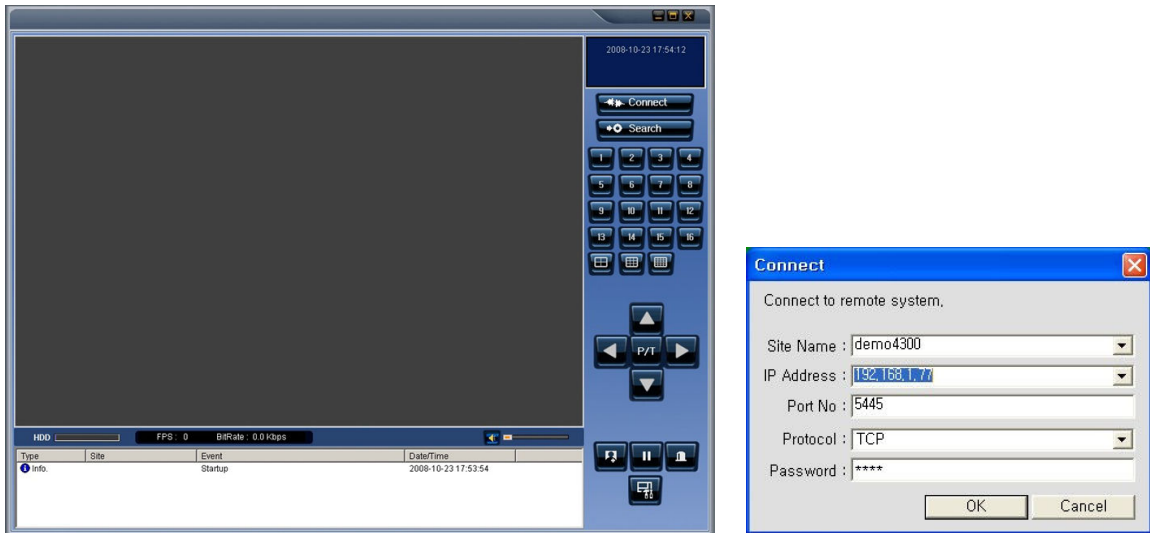

4. Input IP address, Port No., and Password on the connect window. And click OK.

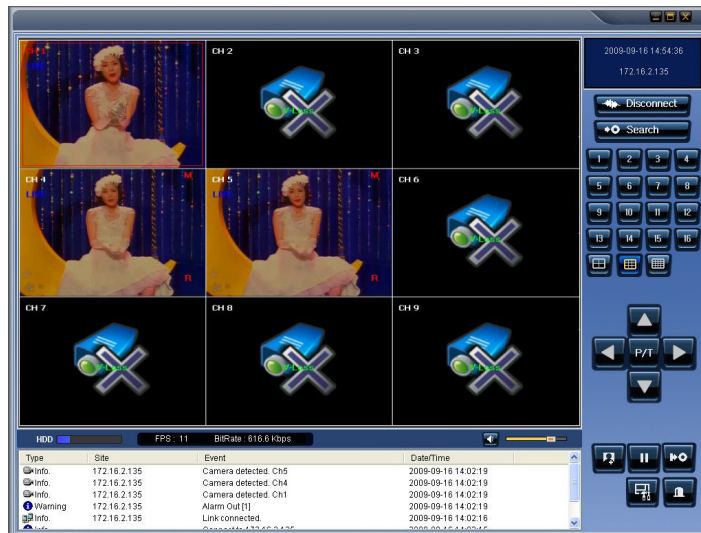

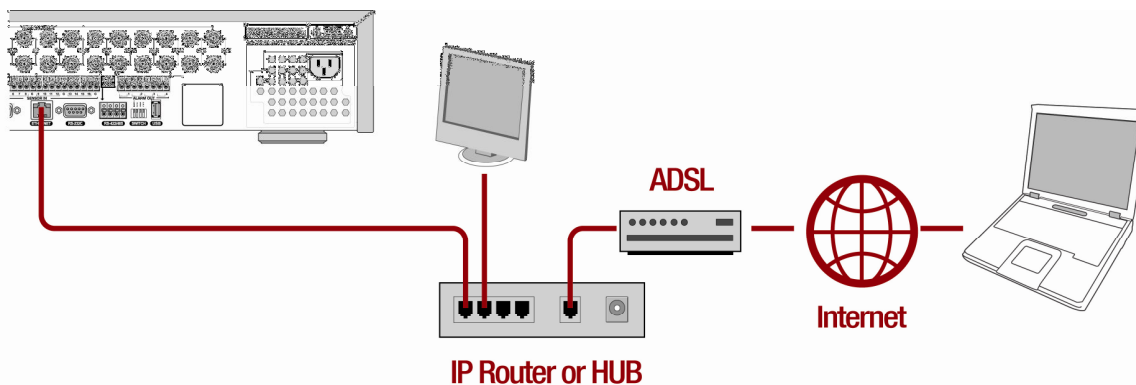

Internet (ADSL) Connection using DDNS

Connect to the system, using an Router or ADSL modem and an Ethernet cable (10BASE-T/100BASE-TX CAT 5 LAN cable)

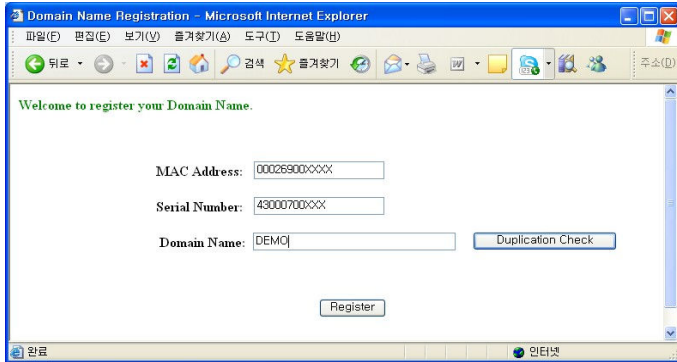

1. Go to SETUP>NETWORK. Set NETWORK TYPE as DHCP and DDNS SERVER as ON. And make sure that DDNS SERVER NAME is bestdns.com
2. Go to Setup menu of Router and open TCP port 5445 using Port Forwarding. (Refer to A. How to set IP address of the DVR and open TCP port of the router?)
3. Confirm the Mac address and Serial No. from the label of the rear panel of the DVR.
4. Open the web browser and log on <http://www.bestdns.com>



- MAC Address: Input the Mac address (EX. 0002690XXXXX) without a space.
 - Serial Number: Input the Serial No. (EX. 43000700XXX.) without a space.
5. Domain Name: Input Domain Name for your DVR system
 6. Click the DUPLICATION CHECK button to see if the domain name is available.
 7. If you see the screen “You can use the Domain name you entered” then click RETURN and click REGISTER button to complete the registration.
 8. Run the pre-install the network client software on the supplied CD. (Refer to Chapter 6. Network access using the Exclusive network viewer)
9. Click  button and add the DVR as necessary.

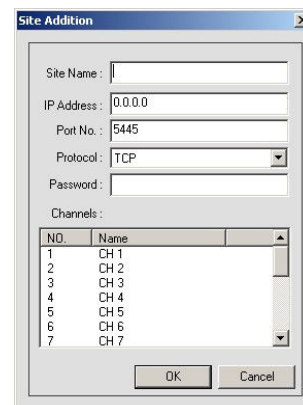
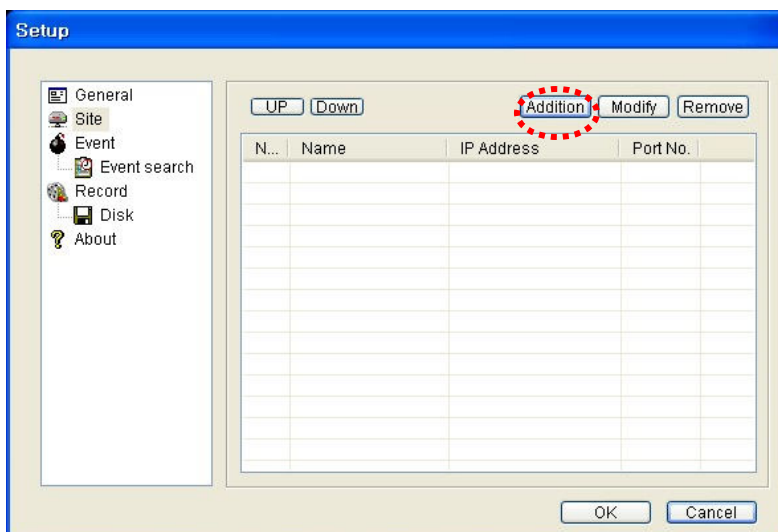

- Site Name: Input the name of the DVR.
- IP Address: Input the Domain Name that is registered on <http://www.bestdns.com> (EX. XXXXX.bestdns.com)
- Port Number: Input the port number.
- Protocol: Select TCP.

- Password: Input the network password.

10. Click Connect button. Then the Connect window is displayed.

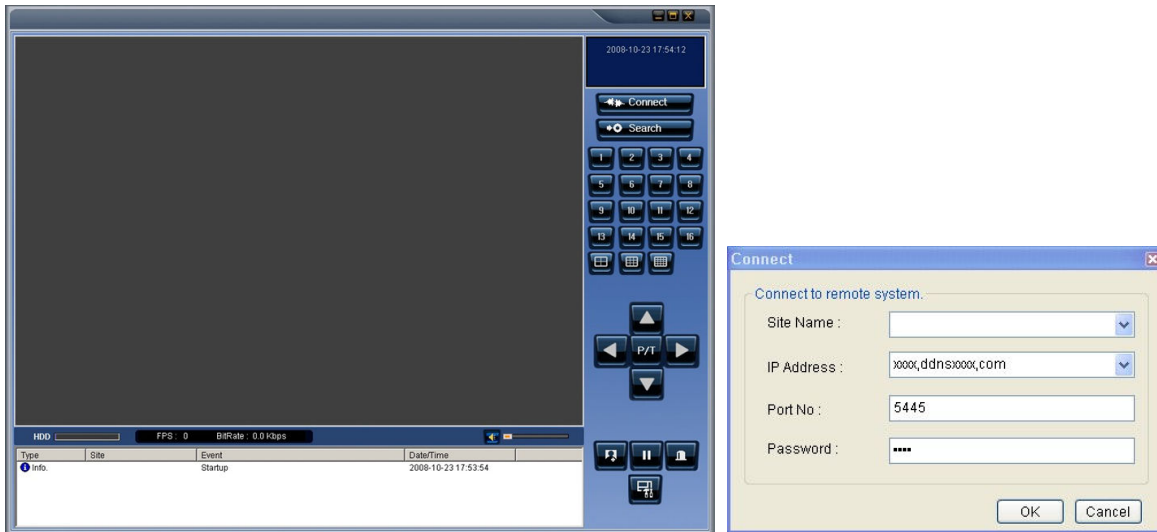

11. Select the site that you will access and click OK.

